



Furniture Catalogue

Volume 18 2022/2023

www.officeworkstations.com.au

WORKSTATIONS - FURNITURE - SEATING - STORAGE - ACCESSORIES

rapidline
FURNITURE FOR TODAY

CONTENTS

4-11	Reception and Lounge
12-15	Rapid Eternity
16-19	Deluxe Infinity
20-23	Deluxe Infinity & Eternity Accessories
24-27	SHUSH30+ NEW
28-30	BOOST+ NEW
31	Height Adjustable Solutions
32	Monitor Arms
33-35	Rapid Screen
36-38	Deluxe Rapid Span & Rapid Span
39-43	Rapid Worker NEW
44-45	Rapid Vibe
46-47	Softwiring
48-53	Tables
54-68	Chairs
69	Rapidline Upholstery NEW
70-71	Presentation
72-73	Screens NEW
74-75	Personal Storage
76-78	Steel Storage
79	Accessories
80-83	Lockers and Accessories

Your Rapidline product is delivered from distribution centres throughout Australia in Sydney, Melbourne, Brisbane, Perth and Adelaide, with a local customer service team in each location.

We not only deliver in these areas but also offer a full installation service.

Have a requirement for an office fitout?

Our in-house projects team can design any layout with Rapidline furniture specific to your requirements.

*We cannot guarantee colours shown in this catalogue are the exact true representation of product colours.

*Specifications subject to change.



RECEPTION & LOUNGE



RECEPTION & LOUNGE

URBAN RECEPTION COUNTER - URC NW/DW

Dimensions :

Width	2200mm
Depth	800mm
Height	1150mm
Counter Height	750mm

Finish :

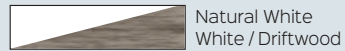

Features :

- Driftwood wrap around cowl feature panel
- Built in lockable 3 drawer under-desk pedestal
- Built in CPU & storage cupboard
- 2 x chrome cable entry hole covers

Certifications :



MARQUEE RECEPTION COUNTER - MRC GW/ZB

Dimensions :

Width	2400mm
Depth	835mm
Height	1150mm
Counter Height	750mm

Finish :



Features :

- Zebra veneer front columns
- Built in lockable 3 drawer under-desk pedestal
- Built in CPU & storage cupboard
- 2 x chrome cable entry hole covers with brush insulators

Certifications :



5-O RECEPTION COUNTER - RC5-O GW

Dimensions :

Width	2400mm
Depth	848mm
Height	1100mm
Counter Height	750mm

Finish :



Features :

- Chrome trim detail on front panel
- Large work surface
- 2 x chrome cable entry hole covers with brush insulators
- E0 Melamine board

Certifications :



RC1809 RECEPTION COUNTER - RC1809 NW

Dimensions :

Width	1800mm
Depth	800mm
Height	1170mm
Counter Height	750mm

Finish :



Features :

- Black powdercoated perforated cowl
- Black matching kickplate
- E0 Melamine board

Certifications :



FLOW RECEPTION COUNTER - NCT1160

Dimensions :

Overall Width x Depth	2400 x 1600mm
Worksurface Depth	800mm
Height	1160mm
Counter Height	730mm

Finish :



Features :

- Curved reception counter
- Glass feature on side
- High reception hob for privacy
- Can be used as Left or Right hand return

Certifications :



RAPID BLOOM VERTICAL GARDEN - SRBVG BK | SRBVG WH

Dimensions :

Width	395mm
Depth	210mm
Height	1940mm
Weight	34kg

Features :

- 8 x 150mm diameter round pots
- 20kg of polished stones
- Wall & Floor mounting provisions
- *Plants not included*

Finish Options :

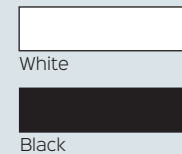

Certifications :



MODULAR RECEPTION COUNTER - MOD1NW | MOD2NW

MOD1NW · Full Height Module

Width	1339mm
Depth	800mm
Height	1160mm
Counter Height	730mm

MOD2NW · Glass Top Module

Width	1339mm
Depth	800mm
Height	935mm
Counter Height	730mm

Finish :



Certifications :



Features :

- Mix and match modular peices to suit your space
- E0 Melamine board

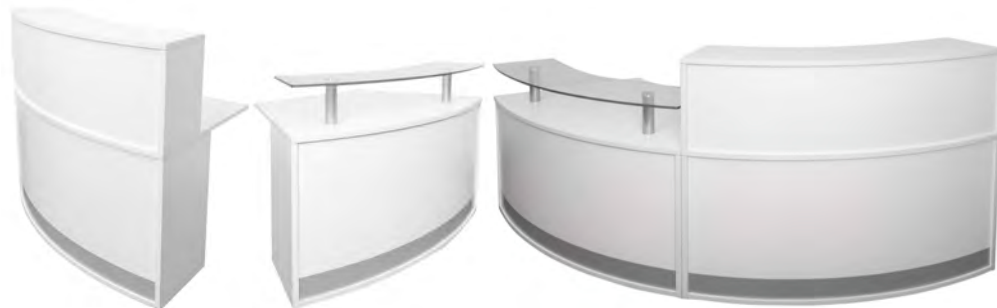

SEMPRE RECEPTION COUNTER - SEMPRE

Dimensions :

Width x Depth	2400mm x 950mm
Height	1150mm
Counter Height	730mm

Finish Options :



Features :

- Melamine feature module, powdercoat aluminium strips
- 500mm W x 50mm D Scallop cutout in work top
- Semi assembled, slide-together design
- Support rail under work top

Certifications :



RECEPTION & LOUNGE

Flexi Lounge allows you to create a lounge area your way. Mix and match sizes and colours along walls, around corners or in the middle of a space.

Finish Options :



FLEXI MODULAR LOUNGE

SINGLE SEAT AND BACK REST - FL1

925mm W x 940mm D x 710mm H



TRIPLE SEAT AND BACK REST - FL2

1830mm W x 940mm D x 710mm H



SINGLE BACK TO BACK - FL3

925mm W x 1880mm D x 710mm H



TRIPLE BACK TO BACK - FL4

1830mm W x 1880mm D x 710mm H



STRETCH - FL5

2755mm W x 940mm D x 710mm H



RETURN LOUNGE - FLRL

1245mm W x 585mm D x 430mm H



CORNER - FL6

2770mm W x 1830mm D x 710mm H



ISLAND - FL7

2755mm W x 1880mm D x 710mm H



MARS ROUND OTTOMAN - MARS R

Dimensions :

Diameter	550mm
Height	450mm
Weight Rating	130kg

Features :

- Soft fabric upholstery
- Concealed black feet
- Match with square and triangle Mars ottomans

Finish Options :

 Charcoal

Rapidline Upholstery See Page 69

Certifications :



*Standard Charcoal



*Pictured in Essence Fabric Surface textiles, Yarra Range

MARS SQUARE OTTOMAN - MARS S

Dimensions :

Width	550mm
Depth	550mm
Height	450mm
Weight Rating	130kg

Features :

- Soft fabric upholstery
- Concealed black feet
- Match with round and triangle Mars ottomans

Finish Options :

 Charcoal

Rapidline Upholstery See Page 69

Certifications :



*Standard Charcoal



*Pictured in Mist Fabric Surface textiles, Yarra Range

MARS TRIANGLE OTTOMAN - MARS T

Dimensions :

Overall Width	550mm
Overall Depth	485mm
Height	450mm
Weight Rating	130kg

Features :

- Soft fabric upholstery
- Concealed black feet
- Match with square and round Mars ottomans

Finish Options :

 Charcoal

Rapidline Upholstery See Page 69

Certifications :



*Standard Charcoal



*Pictured in Seafoam Fabric Surface textiles, Yarra Range

CONNECT 2 OTTOMAN - CONNECT2

Dimensions :

Diameter	320mm
Height	420mm
Weight Rating	110kg

Features :

- Steel underbase storage
- Upholstered seat cushion
- Can be upholstered in house fabrics

Finish Options :

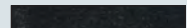
 Black

Rapidline Upholstery See Page 69

Certifications :



*Standard Black



*Pictured in Steel Fabric Surface textiles, Yarra Range

CARDINAL SINGLE LOUNGE - CSA

Dimensions :

Overall W x D x H	755 x 800 x 880mm
Seat W x D x H	450 x 480 x 450mm
Back W x H	700 x 530mm
Weight Rating	Up to 150kg

Finish Options :

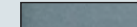
 Light Blue

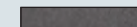
 Charcoal Ash

Certifications :



Features :

- Full fabric upholstery
- Removable seat & back cushion
- Powdercoated solid tube frame



CARDINAL TWO SEATER LOUNGE - CSA2

Dimensions :

Overall W x D x H	1335 x 800 x 880mm
Seat W x D x H	960 x 500 x 430mm
Back W x H	960 x 530mm
Weight Rating	Up to 200kg

Finish Options :

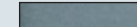
 Light Blue

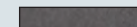
 Charcoal Ash

Certifications :



Features :

- Full fabric upholstery
- Removable seat & back cushion
- Powdercoated solid tube frame



RECEPTION & LOUNGE

SINGLE LOUNGE SEAT - SPACE1

Dimensions :

Overall W x D x H	885 x 720 x 710mm
Seat W x D x H	550 x 515 x 445mm
Back W x D x H	570 x 120 x 310mm
Weight Rating	Up to 150kg

Finish :

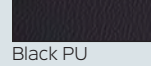

Certifications :



Features :

- Soft, comfortable single lounge
- Black polyurethane finish
- Stylish chrome wrap around frame



TWO SEATER LOUNGE - SPACE2

Dimensions :

Overall W x D x H	1140 x 720 x 710mm
Seat W x D x H	1110 x 515 x 445mm
Back W x D x H	1110 x 120 x 310mm
Weight Rating	Up to 200kg

Finish :

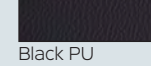

Certifications :



Features :

- Available in 2 other matching sizes
- Two seater lounge
- Modern, comfortable seating



THREE SEATER LOUNGE - SPACE3

Dimensions :

Overall W x D x H	1960 x 720 x 710mm
Seat W x D x H	1670 x 515 x 445mm
Back W x D x H	1670 x 120 x 310mm
Weight Rating	Up to 300kg

Finish :

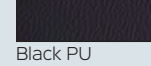

Certifications :



Features :

- Easy cleaning and maintenance
- Spacious 3 seater lounge



CAPRI 1 SEATER - CAPRI1

Dimensions :

Overall W x D x H	746W x 750D x 830H
Seat W x D x H	580W x 510D x 450H
Back W x D x H	580W x 510D x 410H
Weight Rating	Up to 150kg

Finish :

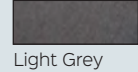

Features :

- Durable powdercoated steel base
- Strong 12mm plywood skeleton
- High density foam



CAPRI 3 SEATER - CAPRI3

Dimensions :

Overall W x D x H	1950W x 750D x 830H
Seat W x D x H	1780W x 510D x 450H
Back W x D x H	1780W x 510D x 410H
Weight Rating	Up to 375kg

Finish :

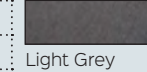

Features :

- Durable powdercoated steel base
- Strong 12mm plywood skeleton
- High density foam



VENUS OTTOMAN - VENUS ST

Dimensions :

Width	1030mm
Depth	540mm
Height	410mm
Weight Rating	Up to 120kg

Finish :



Certifications :



Features :

- PU Finish for Easy Maintenance
- Button Stitching Detail
- Stainless Steel Frame



SPACE TUB - SPTUB1

Dimensions :

Overall W x D x H	650 x 500 x 730mm
Seat W x D x H	540 x 430 x 446mm
Back Height	370mm
Weight Rating	Up to 120kg

Finish :

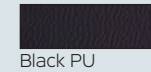

Certifications :



Features :

- Compact size
- Soft foam seat
- Black polyurethane upholstery



SPACE EXECUTIVE TUB - SPEXEC TUB

Dimensions :

Overall W x D x H	600 x 600 x 770mm
Seat W x D x H	480 x 470 x 480mm
Back Height	390mm
Weight Rating	Up to 120kg

Finish :

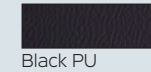

Certifications :



Features :

- Comfortable Larger Tub Seat
- Flared Arm Rest
- Stitching Detail on Back Rest



VENUS SINGLE LOUNGE SEAT - VENUS1

Dimensions :

Overall W x D x H	870 x 740 x 750mm
Seat W x D x H	630 x 500 x 420mm
Back W x D x H	630 x 110 x 400mm
Weight Rating	Up to 150kg

Finish :

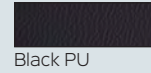

Certifications :



Features :

- Button detail finish
- Black polyurethane upholstery
- Stainless steel frame



VENUS TWO SEATER LOUNGE - VENUS2

Dimensions :

Overall W x D x H	1370 x 740 x 750mm
Seat W x D x H	1120 x 500 x 420mm
Back W x D x H	1120 x 110 x 400mm
Weight Rating	Up to 200kg

Finish :

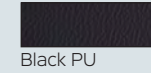

Certifications :



Features :

- Easy Maintenance
- Black polyurethane upholstery
- Stainless steel frame



VENUS THREE SEATER LOUNGE - VENUS3

Dimensions :

Overall W x D x H	2010 x 740 x 750mm
Seat W x D x H	1770 x 500 x 420mm
Back W x D x H	1170 x 110 x 400mm
Weight Rating	Up to 300kg

Finish :

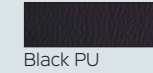

Certifications :



Features :

- Large three seater
- Black polyurethane upholstery
- Stainless steel frame



RECEPTION & LOUNGE

ASPEN TUB - ASPEN

Dimensions :

Overall W x D x H	620 x 600 x 720mm
Seat W x D x H	460 x 440 x 470mm
Back Height	330mm
Weight Rating	Up to 120 kg

Features :

- Comfortable tub chair
- High density moulded foam
- Natural Ash wooden base
- Steel skeleton in seat

Finish :

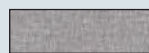

Light Grey



OPAL TUB - OPAL LG

Dimensions :

Overall W x D x H	690 x 660 x 750mm
Seat W x D x H	430 x 400 x 410mm
Back Height	350mm
Weight Rating	Up to 120kg

Features :

- Moulded foam seat and back
- Strong, powdercoated, steel underframe
- Full Fabric Upholstery
- Adjustable feet

Finish :



Light Grey



SPLASH CUBE SINGLE CHAIR - SPLASH CUBE

Dimensions :

Overall W x D x H	655 x 570 x 725mm
Seat W x D x H	460 x 520 x 500mm
Back W x H	460 x 330mm
Weight Rating	Up to 120kg

Features :

- Contemporary style
- Cube shaped chair
- Chrome sled base underframe

Finish Options :

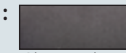

Charcoal

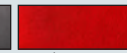

Red



CLOVER TUB CHAIR - CLOVER CH

Dimensions :

Overall W x D x H	680 x 550 x 795mm
Seat W x D x H	530 x 460 x 445mm
Back W x H	520 x 400mm
Weight Rating	Up to 130kg

Features :

- Full fabric single lounge
- Stylish tapered back rest
- Angled cut arm rests

Finish :

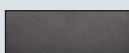

Charcoal



ETERNITY ROUND COFFEE TABLE - ECT66

Dimensions :

ECT600	600mm dia
ECT900	900mm dia
Height	450mm

Top Finish :

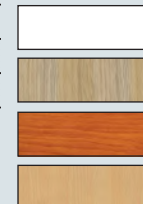

Base Finish :

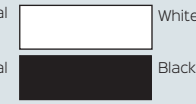

Features :

- Powdercoat legs
- Set of 4 legs
- Adjustable feet
- Matches Eternity workstation range

Certifications :



ETERNITY SQUARE COFFEE TABLE - ECT99

Dimensions :

Width	900mm
Depth	900mm
Height	450mm

Top Finish :

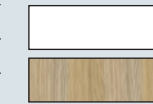

Base Finish :



Features :

- Powdercoat legs
- Set of 4 legs
- Adjustable feet
- Matches Eternity workstation range

Certifications :



ROUND COFFEE TABLE - CCT6

Dimensions :

Top Diameter	600mm
Overall Height	450mm
Overall Height	450mm

Top Finish :

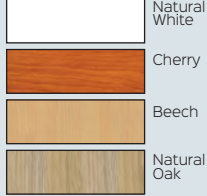

Base Finish :

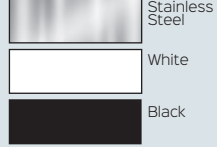

Certifications :



Features :

- Flat disc base
- Multiple colour choices
- Mix and match colours
- E0 Melamine board

ETERNITY RECTANGULAR COFFEE TABLE - ECT126

Dimensions :

Overall Width	1200mm
Overall Depth	600mm
Overall Height	450mm

Top Finish :

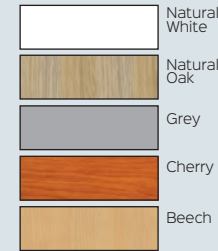

Base Finish :

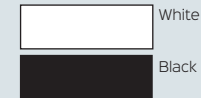

Certifications :



Features :

- Powdercoat Frame
- Double support rails
- E0 Melamine board
- Mix and Match top and frame colours



BUDGET COFFEE TABLE - CT96

Dimensions :

Table Top Width	900mm
Table Top Depth	600mm
Table Top Height	425mm

Finish :

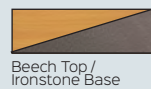

Features :

- Robust design with magazine shelf
- 25mm Melamine Beech top
- Melamine Ironstone base
- E0 Melamine board

Certifications :



GLASS COFFEE TABLE

Dimensions :

Table Top Width	• AGT66 - 600mm • AGT126 - 1200mm
Table Top Depth	600mm
Table Top Height	450mm

Finish :

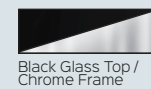

Features :

- Black glass and Chrome frame
- Available in two sizes
- Square or rectangular shape

Certifications :



ETERNITY SIDE TABLE - EST34

Dimensions :

Width	300mm
Depth	400mm
Height	600mm

Top Finish :

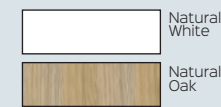

Base Finish :

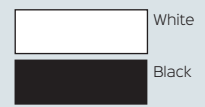

Features :

- Powdercoat Frame
- E0 rated melamine top
- Slides under lounges

Certifications :



RAPID ETERNITY - SINGLE SIDED

ETERNITY SINGLE SIDED WORKSTATIONS



D-ELS1P1575 NW / WS
1 Person | 1500mm
Natural White on White Satin



D-ELS1P1575 NO / BL
1 Person | 1500mm
Natural Oak on Black



D-ELS3P1575 NO / WS
3 Person | 1500mm per user
Natural Oak on White Satin

Create a space efficient workspace with Rapid Eternity, designed to maximise leg space, workstation strength and user communication.

Features :

- Stylish Eternity angled leg
- Maximise office space
- Various sizes available
- 750mm Depth work top per user

Single Sided Workstation Options :

- Choose the number of persons required for your run of desks
- Choose between 1200mm, 1500mm or 1800mm desks
- Choose between black or white powdercoated frames and legs
- Choose between natural oak or natural white scalloped top

Dimensions :

*Overall Measurements

Product	Users	Width	Depth	Height
D-ELS1P1275	1	1200mm	750mm	730mm
D-ELS1P1575	1	1500mm	750mm	730mm
D-ELS1P1875	1	1800mm	750mm	730mm
D-ELS2P1275	2	2400mm	750mm	730mm
D-ELS2P1575	2	3000mm	750mm	730mm
D-ELS2P1875	2	3600mm	750mm	730mm
D-ELS3P1275	3	3600mm	750mm	730mm
D-ELS3P1575	3	4500mm	750mm	730mm
D-ELS3P1875	3	5400mm	750mm	730mm

Top Finishes :

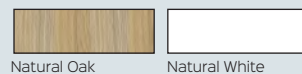

Leg and Frame Finishes :



Certifications :



ETERNITY SINGLE SIDED WORKSTATIONS WITH SCREENS



D-ELSW1P1575 NW / BL
1 Person | 1500mm
Natural White on Black



D-ELSW1P1575 NO / WS
1 Person | 1500mm
Natural Oak on White Satin



D-ELSW2P1575 NO / BL
2 Person | 1500mm per user
Natural Oak on Black

ETERNITY SINGLE SIDED WORKSTATIONS WITH SCREENS

Features :

- Stylish Eternity angled leg
- Maximise office space
- Various sizes available
- 750mm Depth work top per user
- 730mm Desk height

Single Sided Workstations with Screens Options :

- Choose the number of persons required for your run of desks
- Choose between 1200mm, 1500mm or 1800mm desks
- Choose between black or white powdercoated frames and legs
- Choose between natural oak or natural white scalloped top
- Comes with 495mm high x 30mm thick fabric screens
- Choose between black fabric screen with white frame or grey fabric screen with black frame

Dimensions :

*Overall Measurements

Product	Users	Width	Depth	Height (Incl. screens)
D-ELSW1P1275	1	1200mm	780mm	1200mm
D-ELSW1P1575	1	1500mm	780mm	1200mm
D-ELSW1P1875	1	1800mm	780mm	1200mm
D-ELSW2P1275	2	2400mm	780mm	1200mm
D-ELSW2P1575	2	3000mm	780mm	1200mm
D-ELSW2P1875	2	3600mm	780mm	1200mm
D-ELSW3P1275	3	3600mm	780mm	1200mm
D-ELSW3P1575	3	4500mm	780mm	1200mm
D-ELSW3P1875	3	5400mm	780mm	1200mm

Top Finishes :

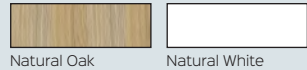

Natural Oak Natural White

Leg and Frame Finishes :



Black Powdercoat White Powdercoat

Screen Finishes :



Grey Fabric /
Black Frame Black Fabric /
White Frame

Rapidline
Upholstery

See Page 69



Certifications :



ETERNITY SINGLE SIDED CORNER WORKSTATIONS



D-ELCWS1P1818 NW / BL
1 Person | 1800 x 1800mm
Natural White on Black



D-ELCWS1P1818 NO / WS
1 Person | 1800 x 1800mm
Natural Oak on White Satin



D-ELCWS1P1818 NO / BL
1 Person | 1800 x 1800mm
Natural Oak on Black

Features :

- Maximise office space
- Various sizes available
- 750mm Depth work top per user
- Create a full matching suite with your Eternity desks

Single Corner Workstations Options :

- Choose between 1500 x 1500mm, 1800 x 1500mm or 1800 x 1800mm individual corner desks
- Choose black or white powdercoated frames and end legs
- Choose between natural oak or natural white top finishes
- All corner tops come with cable access hole

Dimensions :

*Overall Measurements

Product	Users	Width	Depth	Height
D-ELCWS1P1515	1	1500 x 1500mm	750mm	730mm
D-ELCWS1P1815	1	1800 x 1500mm	750mm	730mm
D-ELCWS1P1818	1	1800 x 1800mm	750mm	730mm

Top Finishes :



Natural Oak

Natural White

Certifications :



Leg and Frame Finishes :



Black Powdercoat

White Powdercoat

The Rapid Eternity Corner Workstation is a modular system that can suit any number of users required, with or without screens and accessories.

Matching round table and high bar table available.

Contact us today for more information.



RAPID ETERNITY - DOUBLE SIDED

ETERNITY DOUBLE SIDED WORKSTATIONS



D-ELD2P1575 NO / BL
2 Person | 1500mm
Natural Oak on Black

Features :

- Stylish Eternity angled leg
- Maximise office space
- Various sizes available
- 750mm Depth work top per user

Double Sided Workstations Options :

- Choose the number of persons required for your run of desks
- Choose 1200mm, 1500mm or 1800mm desks
- Choose black or white powdercoated frames and legs
- Choose natural oak or natural white scalloped top
- Choose to have optional infill rail to fill centre 30mm gap - see Infinity accessories page 22.

Dimensions :

*Overall Measurements

Product	Users	Width	Depth	Height
D-ELD2P1275	2	1200mm	1530mm	730mm
D-ELD2P1575	2	1500mm	1530mm	730mm
D-ELD2P1875	2	1800mm	1530mm	730mm
D-ELD4P1275	4	2400mm	1530mm	730mm
D-ELD4P1575	4	3000mm	1530mm	730mm
D-ELD4P1875	4	3600mm	1530mm	730mm
D-ELD6P1275	6	3600mm	1530mm	730mm
D-ELD6P1575	6	4500mm	1530mm	730mm
D-ELD6P1875	6	5400mm	1530mm	730mm



D-ELD4P1575 NW / BL
4 Person | 1500mm
Natural White on Black



D-ELD6P1875 NO / WS
6 Person | 1800mm per user
Natural Oak on White Satin

Top Finishes :

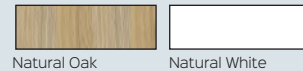

Leg and Frame Finishes :

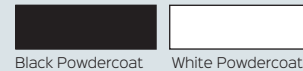

Certifications :



The Rapid Eternity is a modular system that can suit any number of users required, contact us today for more information.



ETERNITY DOUBLE SIDED WORKSTATIONS WITH SCREENS



D-ELDWS2P1575 NO / WS
2 Person | 1500mm
Natural Oak on White Satin



D-ELDWS4P1575 NW / WS
4 Person | 1500mm
Natural White on White Satin



D-ELDWS6P1875 NO / BL
6 Person | 1800mm per user
Natural Oak on Black

ETERNITY DOUBLE SIDED WORKSTATIONS WITH SCREENS

Features :

- Stylish Eternity angled leg
- Maximise office space
- Various sizes available
- 750mm Depth work top per user
- 730mm Desk height

Double Sided Workstations with Screens Options :

- Choose the number of persons required for your run of desks
- Choose between 1200mm, 1500mm or 1800mm desks
- Choose between black or white powdercoated frames and legs
- Choose between natural oak or natural white scalloped top
- Comes with 500mm high x 30mm thick fabric screens
- Choose between black fabric screen with white frame or grey fabric screen with black frame

Dimensions :

*Overall Measurements

Product	Users	Width	Depth	Height (Incl. screens)
D-ELDWS2P1275	2	1200mm	1530mm	1200mm
D-ELDWS2P1575	2	1500mm	1530mm	1200mm
D-ELDWS2P1875	2	1800mm	1530mm	1200mm
D-ELDWS4P1275	4	2400mm	1530mm	1200mm
D-ELDWS4P1575	4	3000mm	1530mm	1200mm
D-ELDWS4P1875	4	3600mm	1530mm	1200mm
D-ELDWS6P1275	6	3600mm	1530mm	1200mm
D-ELDWS6P1575	6	4500mm	1530mm	1200mm
D-ELDWS6P1875	6	5400mm	1530mm	1200mm

Top Finishes :

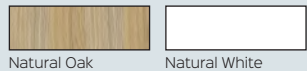

Natural Oak

Natural White

Leg and Frame Finishes :



Black Powdercoat

White Powdercoat

Screen Finishes :

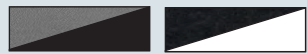

Grey Fabric /
Black Frame

Black Fabric /
White Frame



See Page 69

Certifications :



E0 Board

AFRDI



ETERNITY 4-PERSON POD OF CORNER WORKSTATIONS WITH SCREENS

D-ELCWS4P1818 NO / WS

4 Person | 1800 x 1800mm per user | Natural Oak on White Satin



D-ELCWS4P1818 NW / BL

4 Person | 1800 x 1800mm per user | Natural White on Black



D-ELCWS4P1818 NO / BL

4 Person | 1800 x 1800mm per user | Natural Oak on Black



Features :

- Maximise office space
- Encourage team work
- 750mm Depth work top per user
- 3 workstation sizes available

4-Pod Corner Workstations with Screen Options :

- Choose between 1500 x 1500mm, 1800 x 1500mm or 1800 x 1800mm individual corner desk tops
- Choose between black or white powdercoated frames and legs
- Choose between natural oak or natural white scalloped top
- Comes with 500mm high x 30mm thick fabric screens
- Choose between black fabric screen with white frame or grey fabric screen with black frame

Dimensions :

*Overall Measurements

Product	Users	Width	Depth	Height
D-ELCWS4P1515	4	3030 x 3030mm	1500mm	1200mm
D-ELCWS4P1815	4	3630 x 3030mm	1500mm	1200mm
D-ELCWS4P1818	4	3630 x 3630mm	1500mm	1200mm

Top Finishes :

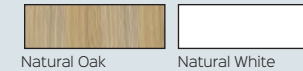

Natural Oak

Natural White

Leg and Frame Finishes :



Black Powdercoat

White Powdercoat

Screen Finishes :



Grey Fabric /
Black Frame

Black Fabric /
White Frame

Certifications :



E0 Board

AFRDI

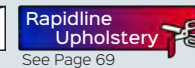

See Page 69



DELUXE RAPID INFINITY

DELUXE RAPID INFINITY SINGLE SIDED WORKSTATIONS

D-IPLS1P1875 NO / WS
Natural Oak, White Satin
Profile Leg
1 Person



Create a space efficient workspace with Deluxe Rapid Infinity, designed to maximise leg space, workstation strength and user communication.



Single Sided Workstation Options

- Choose from the Profile or Loop end leg styles
- Choose between 1200mm, 1500mm or 1800mm individual desk top widths x 750mm depth
- Choose the number of persons required for your run of desks
- Choose between black or white powdercoated frames and legs
- Choose between natural oak or natural white scalloped top

Top Finishes :

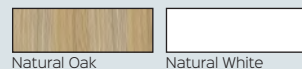

Leg and Frame Finishes :



Profile Leg

*Overall Measurements

Product	Users	Width	Depth	Height
D-IPLS1P1275	1	1200mm	750mm	730mm
D-IPLS1P1575	1	1500mm	750mm	730mm
D-IPLS1P1875	1	1800mm	750mm	730mm
D-IPLS2P1275	2	2400mm	750mm	730mm
D-IPLS2P1575	2	3000mm	750mm	730mm
D-IPLS2P1875	2	3600mm	750mm	730mm
D-IPLS3P1275	3	3600mm	750mm	730mm
D-IPLS3P1575	3	4500mm	750mm	730mm
D-IPLS3P1875	3	5400mm	750mm	730mm

Loop Leg

D-IPLS1P1275	1	1200mm	750mm	730mm
D-IPLS1P1575	1	1500mm	750mm	730mm
D-IPLS1P1875	1	1800mm	750mm	730mm
D-IPLS2P1275	2	2400mm	750mm	730mm
D-IPLS2P1575	2	3000mm	750mm	730mm
D-IPLS2P1875	2	3600mm	750mm	730mm
D-IPLS3P1275	3	3600mm	750mm	730mm
D-IPLS3P1575	3	4500mm	750mm	730mm
D-IPLS3P1875	3	5400mm	750mm	730mm

D-IPLS2P1875 NW / BL
Natural White, Black
Loop Leg
2 Person



D-IPLS3P1875 NO / BL
Natural Oak, Black
Profile Leg
3 Person



SINGLE SIDED WORKSTATIONS WITH SCREENS

D-IILSWS1P1875 NO / BL
Natural Oak, Black
Loop Leg
1 Person



D-IPLSWS2P1875 NO / WS
Natural Oak, White Satin
Profile Leg
2 Person



D-IILSWS3P1875 NW / BL
Natural White, Black
Loop Leg
3 Person

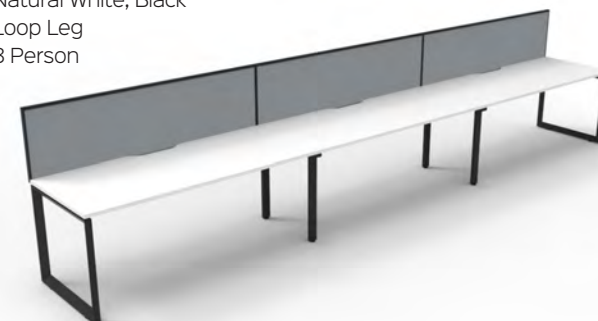

SINGLE SIDED WORKSTATIONS WITH SCREENS

Single Sided Workstations with Screens Options

- Choose from the Profile or Loop end leg styles
- Choose between 1200mm, 1500mm or 1800mm individual desk top widths x 750mm depth
- Choose the number of persons required for your run of desks
- Choose between black or white powdercoated frames and legs
- Choose between natural oak or natural white scalloped top
- Choose between black fabric screen with white frame or grey fabric screen with black frame
- Comes with 500mm high x 30mm thick fabric screen



Top Finishes :



Natural Oak



Natural White

Leg and Frame Finishes :

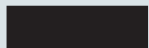

Black Powdercoat



White Powdercoat

Screen Finishes :



Grey Fabric /
Black Frame



Black Fabric /
White Frame

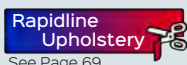

See Page 69



Profile Leg

*Overall Measurements

Product	Users	Width	Depth	Height
D-IPLSWS1P1275	1	1200mm	780mm	1200mm
D-IPLSWS1P1575	1	1500mm	780mm	1200mm
D-IPLSWS1P1875	1	1800mm	780mm	1200mm
D-IPLSWS2P1275	2	2400mm	780mm	1200mm
D-IPLSWS2P1575	2	3000mm	780mm	1200mm
D-IPLSWS2P1875	2	3600mm	780mm	1200mm
D-IPLSWS3P1275	3	3600mm	780mm	1200mm
D-IPLSWS3P1575	3	4500mm	780mm	1200mm
D-IPLSWS3P1875	3	5400mm	780mm	1200mm

Loop Leg

D-ILLSWS1P1275	1	1200mm	780mm	1200mm
D-ILLSWS1P1575	1	1500mm	780mm	1200mm
D-ILLSWS1P1875	1	1800mm	780mm	1200mm
D-ILLSWS2P1275	2	2400mm	780mm	1200mm
D-ILLSWS2P1575	2	3000mm	780mm	1200mm
D-ILLSWS2P1875	2	3600mm	780mm	1200mm
D-ILLSWS3P1275	3	3600mm	780mm	1200mm
D-ILLSWS3P1575	3	4500mm	780mm	1200mm
D-ILLSWS3P1875	3	5400mm	780mm	1200mm

DELUXE RAPID INFINITY DOUBLE SIDED WORKSTATIONS

D-IPLD2P1875 NO / BL

Natural Oak, Black
Profile Leg
2 Person



D-ILLD4P1875 NW / BL

Natural White, Black
Loop Leg
4 Person



D-IPLD6P1875 NO / WS

Natural Oak, White Satin
Profile Leg
6 Person



Deluxe Rapid Infinity is a modular system that can suit any number of users required, contact us for more information.



Double Sided Workstation Options

- Choose the number of persons required for your double sided run of desks
- Choose from the Profile or Loop end leg styles
- Choose between 1200mm, 1500mm or 1800mm individual desk top widths x 750mm depth
- Choose between black or white powdercoated frames and legs
- Choose between natural oak or natural white scalloped top
- Choose to have optional infill rail to fill centre gap - see Infinity accessories page. Or use as cable access gap



Top Finishes :

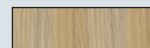

Natural Oak



Natural White

Leg and Frame Finishes :

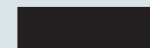

Black Powdercoat



White Powdercoat

Profile Leg

*Overall Measurements

Product	Users	Width	Depth	Height
D-IPLD2P1275	2	1200mm	1530mm	730mm
D-IPLD2P1575	2	1500mm	1530mm	730mm
D-IPLD2P1875	2	1800mm	1530mm	730mm
D-IPLD4P1275	4	2400mm	1530mm	730mm
D-IPLD4P1575	4	3000mm	1530mm	730mm
D-IPLD4P1875	4	3600mm	1530mm	730mm
D-IPLD6P1275	6	3600mm	1530mm	730mm
D-IPLD6P1575	6	4500mm	1530mm	730mm
D-IPLD6P1875	6	5400mm	1530mm	730mm

Loop Leg

D-ILLD2P1275	2	1200mm	1530mm	730mm
D-ILLD2P1575	2	1500mm	1530mm	730mm
D-ILLD2P1875	2	1800mm	1530mm	730mm
D-ILLD4P1275	4	2400mm	1530mm	730mm
D-ILLD4P1575	4	3000mm	1530mm	730mm
D-ILLD4P1875	4	3600mm	1530mm	730mm
D-ILLD6P1275	6	3600mm	1530mm	730mm
D-ILLD6P1575	6	4500mm	1530mm	730mm
D-ILLD6P1875	6	5400mm	1530mm	730mm

DELUXE RAPID INFINITY

DELUXE RAPID INFINITY DOUBLE SIDED WORKSTATIONS WITH SCREENS

D-IPLDWS2P1875 NO / WS
Natural Oak, White Satin
Profile Leg
2 Person



D-ILLDWS4P1875 NW / WS
Natural White, White Satin
Loop Leg
4 Person



D-IPLDWS6P1875 NO / BL
Natural Oak, Black
Profile Leg
6 Person



Double Sided Workstations with Screen Options

- Choose from the Profile or Loop end leg styles
- Choose between 1200mm, 1500mm or 1800mm individual desk top widths x 750mm depth
- Choose the number of persons required for your run of desks
- Choose between black or white powdercoated frames and legs
- Choose between natural oak or natural white scalloped top
- Choose between black fabric screen with white frame or grey fabric screen with black frame
- Comes with 500mm high x 30mm thick fabric screen



Top Finishes

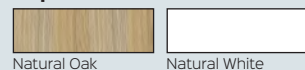

Leg and Frame Finishes



Screen Finishes :

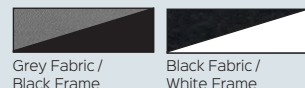

See Page 69



Profile Leg

*Overall Measurements

Product	Users	Width	Depth	Height
D-IPLDWS2P1275	2	1200mm	1530mm	1200mm
D-IPLDWS2P1575	2	1500mm	1530mm	1200mm
D-IPLDWS2P1875	2	1800mm	1530mm	1200mm
D-IPLDWS4P1275	4	2400mm	1530mm	1200mm
D-IPLDWS4P1575	4	3000mm	1530mm	1200mm
D-IPLDWS4P1875	4	3600mm	1530mm	1200mm
D-IPLDWS6P1275	6	3600mm	1530mm	1200mm
D-IPLDWS6P1575	6	4500mm	1530mm	1200mm
D-IPLDWS6P1875	6	5400mm	1530mm	1200mm

Loop Leg

D-ILLDWS2P1275	2	1200mm	1530mm	1200mm
D-ILLDWS2P1575	2	1500mm	1530mm	1200mm
D-ILLDWS2P1875	2	1800mm	1530mm	1200mm
D-ILLDWS4P1275	4	2400mm	1530mm	1200mm
D-ILLDWS4P1575	4	3000mm	1530mm	1200mm
D-ILLDWS4P1875	4	3600mm	1530mm	1200mm
D-ILLDWS6P1275	6	3600mm	1530mm	1200mm
D-ILLDWS6P1575	6	4500mm	1530mm	1200mm
D-ILLDWS6P1875	6	5400mm	1530mm	1200mm

SINGLE CORNER WORKSTATION

D-ILLCWS1P1815 NW / BL
1800mm x 1500mm
Natural White, Black
Loop Leg
1 Person



D-IPLCWS1P1818 NO / WS
1800mm x 1800mm
Natural Oak, White
Profile Leg
1 Person



D-ILLCWS1P1818 NO / BL
1800mm x 1800mm
Natural Oak, Black
Loop Leg
1 Person



SINGLE CORNER WORKSTATION

Single Corner Workstation Options

- Choose from the Profile or Loop end leg styles
- Choose between 1500 x 1500mm, 1800 x 1500mm or 1800 x 1800mm individual corner desk top widths x 750mm depth
- Choose between black or white powdercoated frames and end legs
- Choose between natural oak or natural white top finishes
- All corner tops come with cable access hole

Top Finishes :

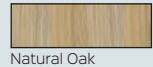

Natural Oak



Natural White

Leg and Frame Finishes :

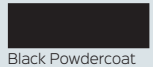

Black Powdercoat

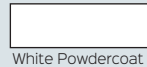

White Powdercoat

Profile Leg

*Overall Measurements

Product Code	Users	Width	Depth	Height
D-IPLCWS1P1515	1	1500 x 1500mm	750mm	730mm
D-IPLCWS1P1815	1	1800 x 1500mm	750mm	730mm
D-IPLCWS1P1818	1	1800 x 1800mm	750mm	730mm

Loop Leg

Product Code	Users	Width	Depth	Height
D-ILLCWS1P1515	1	1500 x 1500mm	750mm	730mm
D-ILLCWS1P1815	1	1800 x 1500mm	750mm	730mm
D-ILLCWS1P1818	1	1800 x 1800mm	750mm	730mm

The Deluxe Rapid Infinity Corner Workstation is a modular system that can suit any number of users required, with or without screens and accessories.

Contact us today for more information.



4-PERSON POD OF CORNER WORKSTATIONS WITH SCREENS

D-ILLCWS4PWS1815 NO / WS

Natural Oak, White Satin

Loop Leg

4 Person



D-IPLCWS4PWS1818 NW / BL

Natural White, Black

Profile Leg

4 Person



D-ILLCWS4PWS1818 NO / BL

Natural Oak, Black

Loop Leg

4 Person



4-Person Corner Workstation Pod With Screen Options

- Choose from the Profile or Loop end leg
- Choose from 1500 x 1500mm, 1800 x 1500mm or 1800 x 1800mm individual corner desk top widths x **750mm depth**
- Choose between natural oak or natural white top finishes
- Choose between black or white powdercoated frames and legs
- Choose between black fabric screen with white frame or grey fabric screen with black frame.
- Fabric screen is 500mm high x 30mm thick

Top Finishes

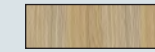

Natural Oak



Natural White

Leg and Frame Finishes



Black Powdercoat



White Powdercoat

Screen Finishes



Grey Fabric / Black Frame



Black Fabric / White Frame



See Page 69



Profile Leg

*Overall Measurements

Product Code	Users	Width	Depth	Height
D-IPLCWS4P1515	4	3000 x 3000mm	1500mm	1200mm
D-IPLCWS4P1815	4	3600 x 3000mm	1500mm	1200mm
D-IPLCWS4P1818	4	3600 x 3600mm	1500mm	1200mm

Loop Leg

D-ILLCWS4P1515	4	3000 x 3000mm	1500mm	1200mm
D-ILLCWS4P1815	4	3600 x 3000mm	1500mm	1200mm
D-ILLCWS4P1818	4	3600 x 3600mm	1500mm	1200mm

Why Choose Deluxe Infinity?

- Black or white leg options
- 750mm deep work top for more space
- Natural white or natural oak top finish options
- Scalloped cable access for straight work tops
- Grey screen available with black frame



DELUXE INFINITY & ETERNITY DESK AND RETURN

ETERNITY DESK AND RETURN

Dimensions :

Width	1800 x 1800mm Overall
Depth	750 at Desk, 600 at Return
Height	730mm

Certifications :



Features :

- 2-Piece top with 90 degree corner
- Double support rails
- Adjustable levelling feet
- 25mm Thick E0 rated melamine board
- Scalloped edge for cable access on one side

Top Options :

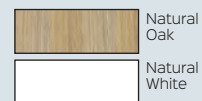

Base Options :

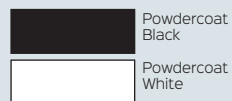

LOOP LEG DESK AND RETURN

Dimensions :

Width	1800 x 1800mm Overall
Depth	750 at Desk, 600 at Return
Height	730mm

Certifications :



Features :

- 2-Piece top with 90 degree corner
- Double support rails
- Adjustable levelling feet
- 25mm Thick E0 rated melamine board
- Scalloped edge for cable access on one side

Top Options :

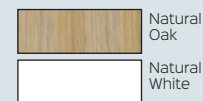

Base Options :

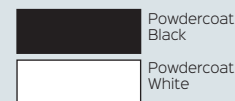

PROFILE LEG DESK AND RETURN

Dimensions :

Width	1800 x 1800mm Overall
Depth	750 at Desk, 600 at Return
Height	730mm

Certifications :



Features :

- 2-Piece top with 90 degree corner
- Double support rails
- Adjustable levelling feet
- 25mm Thick E0 rated melamine board
- Scalloped edge for cable access on one side

Top Options :



Base Options :

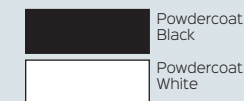

INFINITY SWING DOOR CUPBOARDS

Dimensions :

Options	<ul style="list-style-type: none"> IFSD96 - 2 Door - 900 x 600mm IFSD1245 - 3 Door - 1200 x 450mm IFSD1545 - 3 Door - 1500 x 450mm IFSD1845 - 4 Door - 1800 x 450mm
Height	730mm

Finish Options :



Features :

- Lockable - 2 keys supplied
- Shark nose feature on tops of doors
- Black edging feature
- Adjustable levelling feet & Soft close hinges
- 18mm Thick E0 rated melamine board

Certifications :



INFINITY BOOKCASES

Dimensions :

Options	<ul style="list-style-type: none"> IFBK12 - 1200mm Height IFBK18 - 1800mm Height
Width	900mm
Depth	315mm

Finish Options :

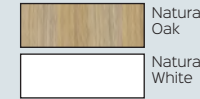

Features :

- Adjustable shelves
- Black edging feature
- Aluminium tapered legs
- 25mm Thick Shelves, 18mm Sides
- E0 rated melamine board

Certifications :



ETERNITY MEETING TABLE

Dimensions :

Round	<ul style="list-style-type: none"> D-ERT9 - 900mm Dia. D-ERT12 - 1200mm Dia.
Square	D-ERT990 - 900W x 900D
Height	730mm

Top Finish :

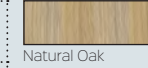

Base Finish :

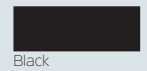
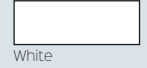

Features :

- Powdercoat base
- 25mm thick E0 Melamine top
- 2mm gauge steel construction
- Matches Eternity range

Certifications :



CLAMP MOUNT SHELF - CMSHELF600

Dimensions :

Width	600mm
Depth	270mm
Height	475mm

Finish Options :

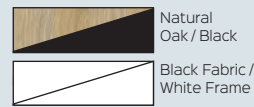

Features :

- 25mm thick E0 rated enviroboard
- Comes with 4 x wire dividers
- Convenient shelf above desk top
- Clamps onto desk top

Certifications :



INFINITY DESK MOUNTED SHELF - DMSHELF

Dimensions :

Width	600mm
Depth	300mm
Overall Height	450mm
Desk Top to Shelf Height	208mm

Finish Options :

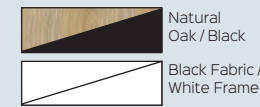

Features :

- 25mm thick E0 rated enviroboard
- Comes with 4 x wire dividers

Certifications :



INFINITY SCREEN HUNG SHELF - ISHELF600

Dimensions :

Width	600mm
Depth	270mm
Height	250mm

Finish Options :

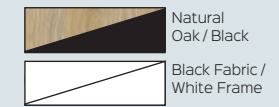

Features :

- 18mm thick E0 rated enviroboard
- Powdercoated steel shelf brackets
- Available in 2 finishes
- Hangs from infinity centre screens

Certifications :



DELUXE INFINITY & ETERNITY ACCESSORIES

FIXED 2400mm LENGTH SUPPORT RAIL - FR2400

Dimensions :

Width	2326mm
Depth	25mm
Height	40mm

Finish Options :

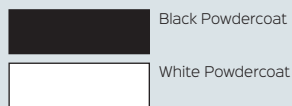

Features :

- Suits 2400mm Wide table tops with Profile legs
- Creates a 2590mm Wide table when used with Eternity legs
- Double support rails to strengthen top
- Comes as a set of 2



DOUBLE TELESCOPIC SUPPORT RAILS

Dimensions :

Options	ITR1012 - 1200mm Desks ITR1518 - 1500 & 1800mm Desks ITR7011 - Corner Workstations
Depth	30mm
Height	30mm

Finish Options :

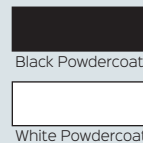

Features :

- Used to strengthen desk tops
- Telescopic rails for 1800mm and under



EXTRA LONG TELESCOPIC SUPPORT RAILS - ITR1812

Dimensions :

Width	1726 - 2106mm
Depth	30mm
Height	30mm

Finish Options :

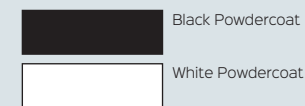

Features :

- Used to create desks 1800mm to 2100mm wide
- Double support rails to strengthen top
- Comes as a set of 2



INFINITY INFILL PANEL

Dimensions :

Width	D-IF12 - 1200mm
Options	D-IF15 - 1500mm D-IF18 - 1800mm
Depth	30mm
Height	30mm

Finish Options :



Features :

- Fills 30mm gap between double sided back to back Deluxe and Infinity workstation ranges



600mm LEGS

Specifications :

PRL600	Profile Leg
LRL600	Loop Leg
ERL600	Eternity Leg

Finish Options :

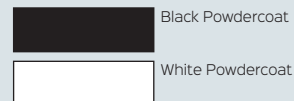

Features :

- Use as a return leg for desk & returns
- Use where recessed legs are required



RAIL CLAMP - IRC

Dimensions :

Width	129mm
Depth	32mm
Height	40mm

Finish Options :

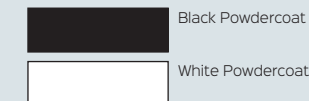

Features :

- Used for corner workstations or desks with returns
- Clamps to double support rails
- Comes in set of 2



DELUXE INFINITY & ETERNITY DESK MOUNTED SCREEN

SHS DESK MOUNTED SCREEN

Dimensions :

Width	SHS754 - 750mm
Options	SHS1204 - 1200mm SHS1504 - 1500mm SHS1804 - 1800mm
Height	495mm
Thickness	30mm

Finish Options :



Rapidline Upholstery See Page 69

NEW



Features :

- Pinnable fabric screen
- Upholster in our range of House Fabrics
- *Requires additional Fixings. Ask us before you order*

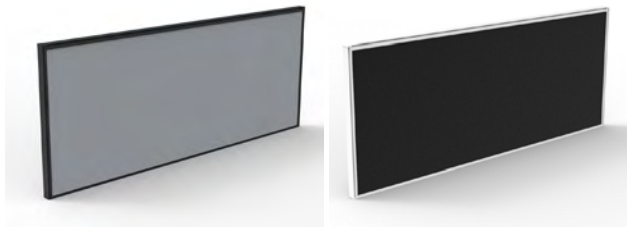

DESK MOUNTED SCREEN JOINING POLES

Specifications :

Height	495mm
Width	30mm
Thickness	30mm

Finish Options :

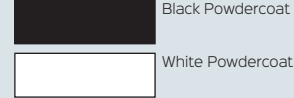

Features :

- Used for joining and stabilising return screens
- Used where screens join at 90 Degrees

NEW



SHSJP495

DESK MOUNTED SCREEN CLAMP

Specifications :

Height	66mm
Width	80mm
Depth	44mm

Finish Options :



Features :

- Use when attaching a screen to a desk where drill holes are not desired
- Screens mounted using this clamp will sit above desk tops
- Better suited to desks with cable entry holes due to the above
- Suits desk thickness up to 26mm
- Comes as set of 2

NEW



SHS-CL

SCREEN FIXING PLATE FOR SINGLE DESKS

Specifications :

Height	40mm
Width	122mm
Depth	100mm

Finish Options :

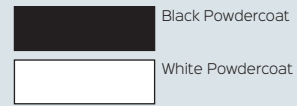

Features :

- Use to fix screens to desks, drill holes required on bottom of desk
- Screens mounted using this clamp will sit flush with desk top
- Better suited to tops with scalloped edge
- Suits desk thickness up to 26mm
- Comes as set of 2

NEW

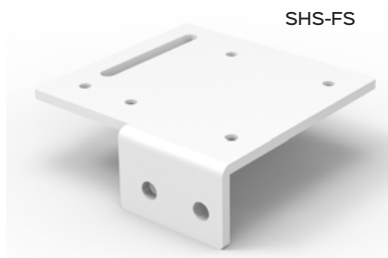

SHS-FS

SCREEN FIXING PLATE FOR BACK TO BACK DESKS

Specifications :

Height	40mm
Width	100mm
Depth	70mm

Finish Options :

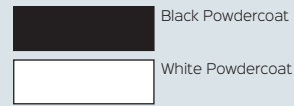

Features :

- Use to fix screens to back to back desk configurations
- Clamp for SHS Desk Mounted Screens
- Suits desk thickness up to 26mm
- Comes as set of 2

NEW

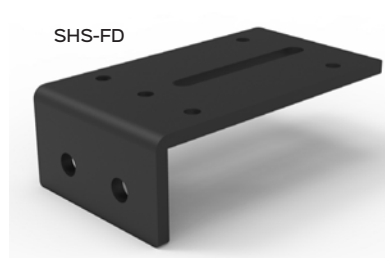

SHS-FD

SCREEN FIXING PLATE FOR RETURN SCREENS

Specifications :

SHS-LB	Use for desk mounted screens on single desks
SHS-TB	Use for desk mounted screens between 2 desks

Features :

- For use with 750mm wide return screens
- 120mm W x 50mm D x 5mm H
- Single Screw Plate Only, not sold in pairs

Finish Options :

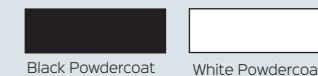

NEW



SHS-LB

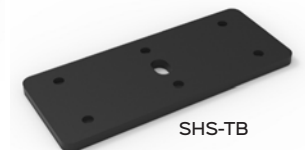

SHS-TB

SHUSH30+ FULL HEIGHT

SHUSH30 SCREEN HUNG WORKSTATIONS



The SHUSH30+ screen range features a 30mm slimline screen with a square profile, powder coat frame and a full fabric pinnable surface with adjustable levelling feet.

The two heights allow for either full communication or some privacy between users.

Comes in 2 standard colour options or can be upholstered in our Rapidline Upholstery Fabrics range.

*Lead times and additional charges apply

SIDE TO SIDE



The SHUSH30+ is a screen system that can create endless configurations.

Create runs of any length, use the 2 different screen heights to create privacy or encourage teamwork. Upholster in a range of Rapidline fabrics and create desks of 3 different sizes.

Top Finishes :

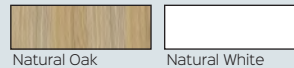

Screen Finishes :

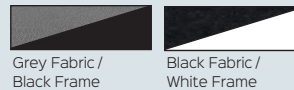

Rapidline Upholstery  See Page 69

Certifications :



BACK TO BACK



Components :

Top Options	Natural Oak or Natural White with scalloped edge DST1275 - 1200mm W x 750mm D DST1575 - 1500mm W x 750mm D DST1875 - 1800mm W x 750mm D
Screen Options	Black frame with Grey Fabric or White frame with Grey fabric SHS712 - 750mm W x 1200mm H x 30mm T SHS1212 - 1200mm W x 1200mm H x 30mm T SHS1512 - 1500mm W x 1200mm H x 30mm T SHS1812 - 1800mm W x 1200mm H x 30mm T SHS715 - 750mm W x 1500mm H x 30mm T SHS1215 - 1200mm W x 1500mm H x 30mm T SHS1515 - 1500mm W x 1500mm H x 30mm T SHS1815 - 1800mm W x 1500mm H x 30mm T
Joining Pole	White or Black SHSJP1200 - Joining Pole for 1200mm Height SHSJP1500 - Joining Pole for 1500mm Height
Joining Brackets	Silver SCDESK BRACKET - Bracket to fasten workstation top to screen Comes as a set of 2

SHUSH30 CUBICLE



SHUSH30 CORNER 1-2 person



SHUSH30 CORNER 4+

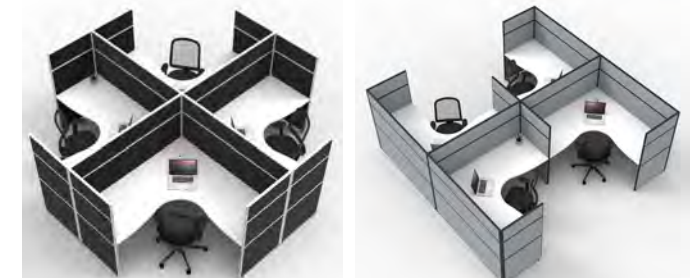
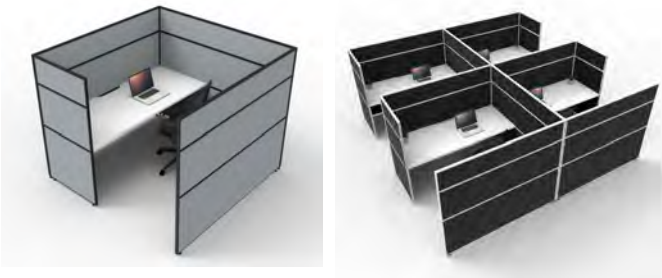

Create freestanding cubicles without constructing permanent walls.

Use taller screens to create private personal pods without the construction of walls.

Join pods to create as many cubicles as you require for your office set up.

Corner desks for more work space per user. Create a free standing self contained temporary cubicle that can be deconstructed and moved.

Components :

Corner	Natural Oak or Natural White with cable entry hole
Top	T1515-75 - 1500mm x 1500mm, 750mm Top Depth
Size	T1812-75 - 1800mm x 1200mm, 750mm Top Depth
Options	T1815-75 - 1800mm x 1500mm, 750mm Top Depth T1818-75 - 1800mm x 1800mm, 750mm Top Depth

Create large team pods.

Use completely screen hung tops or use with Profile, Loop, Eternity, Span or DC-60 end legs.

Use ceiling to workstation power poles and umbilicals to take power and data to the workstations neatly and safely.

SHUSH30+ FULL HEIGHT

LEG OPTIONS

Mix and Match with Profile, Loop, Eternity, Span or DC-60 end legs with middle dividing screens.

Leg Options

- Profile Leg - in Black or White
- Loop Leg - in Black or White
- Eternity Leg - in Black or White
- DC60 - Round leg in Chrome, Black or White
- SPLEG - Span leg in Silver, Black or White

* Additional LRB18 Leg Blocks required for Eternity, Loop and Profile legs. Available in Black or White powdercoat

All options available in :

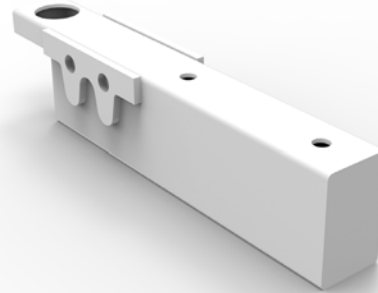

*Pictured : LRB18 - Leg block for Eternity, Loop and Profile legs, comes in a set of 2

FREE STANDING FEET - SHSFOOT

Specifications :

Height	125mm
Width	505mm
Depth	66mm

Finish Options :



Features :

- Used to convert screens in to free-standing screens
- Attaches to side of screen extrusion for a clean finish
- Powdercoat finish
- Comes as a set of 2



*Pictured with Black SPLEG end legs



*Pictured with Black Eternity end legs



*Pictured with White DC-60 end legs

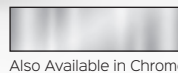

*Pictured with White Loop end legs

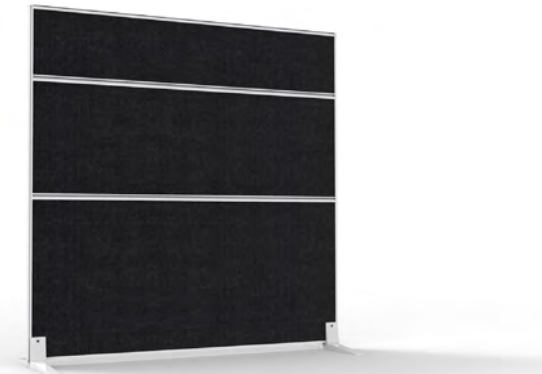



*Pictured with White Free Standing Feet

SHS-HAB BRACKETS

Specifications :

Height	70mm
Width	138mm
Depth	72mm

Finish Options :

	Black Powdercoat
	White Powdercoat

Features :

- Recommended for use with 600mm deep Infinity and Eternity legs
- Used to fit a 900mm H SHUSH30+ screen to a fixed height desk
- Can be fixed at any height on a desk
- Functions as a screen and a modesty panel
- Brackets for screen only. *Does not include screens, clamps or fixings*
- 900mm Height screens also used on Boost+ with additional fixing arms. See Boost+ Range for more information.
- Comes as a set of 2 - 1 x Right, 1 x Left

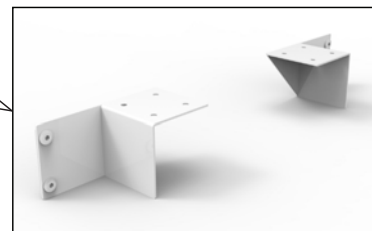
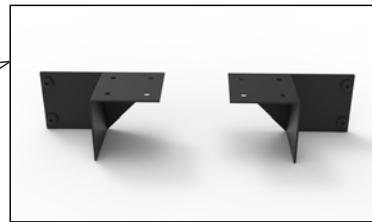
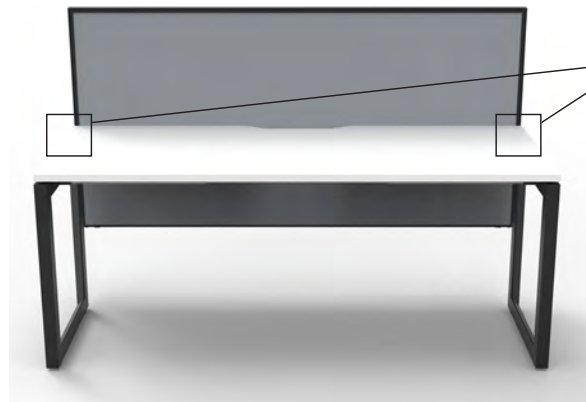



B2-SLIBR BRACKETS

Specifications :

Height	50mm
Width	25mm
Depth	8mm

Finish Options :

	Black Powdercoat
	White Powdercoat

Features :

- Use for 1200mm and 1500mm full height SHUSH30+ screens, with height adjustable workstations such as BOOST+
- Holds the screen sturdy when adjusting height on workstations
- Brackets for screen only. *Does not include screens, clamps or fixings
- Includes Nylon brackets. Comes as a set of 2; 1 x Right, 1 x Left

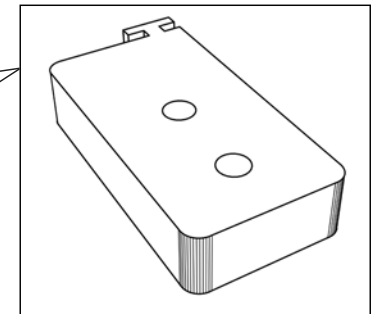

*Pictured Top of Right bracket

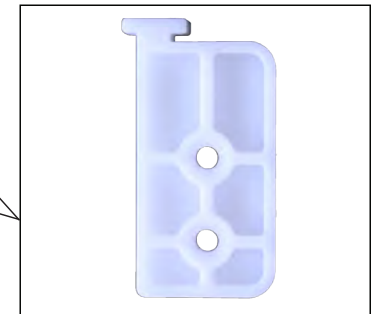

*Pictured Bottom of Right bracket

The BOOST+ is a new and improved range featuring:

- LED digital controller with 3 pre-set programmable heights and easy to use up & down arrows
- 120kg weight lifting capacity on Workstations and 140kg capacity on Corner Desks
- Smooth & quiet adjustment at 38mm per second
 - Anti-collision and anti-tilt safety features
 - Dual motor with 3 stage motorised legs
- Keypad safety lock and reminder alarm setting
 - Adjustable levelling feet
 - Low noise emissions
 - Easy assembly

New Sizes and Configurations:

- Now available in open Desk, Desk with Return and Corner Workstations
 - 3 Open desk sizes and 3 corner workstation sizes
 - Mix and Match 2 top colours with 2 frame colours
- Height range of 620mm - 1270mm H to meet **Australian Standards**
 - 750mm depth top with scalloped cable access

Optional Add-Ons:

- Optional integrated cable tray
- Optional 900mm H, full fabric, pinnable screen for privacy
- Screens available in 2 standard fabrics or our range of Rapidline Upholstery Fabrics on page 69

Optional Accessories:

- Optional Bluetooth control to work with your smart mobile devices
- Optional Portable Battery Packs allow desk mobility free from GPOs
 - Cable snake to make managing wiring simple
- Cable tray bridge for cable management of runs of workstations

BOOST+ CORNER

The Boost+ Corner is a height adjustable corner workstation available in 3 sizes. With a weight capacity of 140kgs and a cable entry hole on the workstation top.

Product Code	Screen	Cable Tray	Size
B+CNR1P1515	No	No	1500 x 1500mm
B+CNRCT1P1515	No	Yes	1500 x 1500mm
B+CNRWS1P1515	Yes	No	1500 x 1500mm
B+CNRWSCT1P1515	Yes	Yes	1500 x 1500mm
B+CNR1P1815	No	No	1800 x 1500mm
B+CNRCT1P1815	No	Yes	1800 x 1500mm
B+CNRWS1P1815	Yes	No	1800 x 1500mm
B+CNRWSCT1P1815	Yes	Yes	1800 x 1500mm
B+CNR1P1818	No	No	1800 x 1800mm
B+CNRCT1P1818	No	Yes	1800 x 1800mm
B+CNRWS1P1818	Yes	No	1800 x 1800mm
B+CNRWSCT1P1818	Yes	Yes	1800 x 1800mm

Top Options :



Frame Finishes :

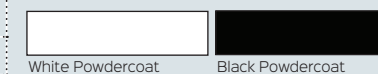

Screen Finishes :

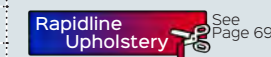
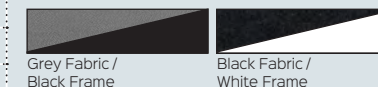

Certifications :



<- Natural Oak top with Black Frame

Natural Oak top with Black Frame -> With Screen and Cable tray

BOOST+ SINGLE DESK

The Boost+ Single Desk comes in 3 widths in our standard range of melamine colours. All tops come with a scalloped edge for cable access. Choose to add on a cable tray, a screen or both.

Product Code	Screen	Cable Tray	Width
B+1P1275	No	No	1200mm
B+1P1575	No	No	1500mm
B+1P1875	No	No	1800mm
B+1PCT1275	No	Yes	1200mm
B+1PCT1575	No	Yes	1500mm
B+1PCT1875	No	Yes	1800mm
B+1PWS1275	Yes	No	1200mm
B+1PWS1575	Yes	No	1500mm
B+1PWS1875	Yes	No	1800mm
B+1PWST1275	Yes	Yes	1200mm
B+1PWST1575	Yes	Yes	1500mm
B+1PWST1875	Yes	Yes	1800mm

Top Options :

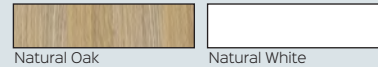

Frame Finishes :



Screen Finishes :

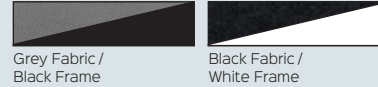

Rapidline Upholstery See Page 69

Certifications :



BOOST+ RETURN FRAME

The Boost+ Return frame can be used with the BOOST+ single desk to create a 2-piece top corner workstation with a 90 degree corner. Total weight capacity of 140kg evenly spread. *Top sold seperately*

Product Code	Width	Height
B2-RF	735 - 1845mm	620 - 1270mm

Frame Options :

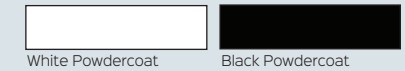

Our stocked return top creates an 1800 x 1800mm overall desk and return.

Product Code	Width	Depth	Height
T116	1100mm	600mm	25mm

Top Options :

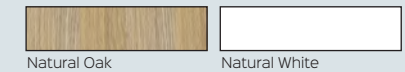

An alternative to the cockpit style corner workstation tops on the Boost+ Corner. And a convenient add-on to a straight Boost+ Single Desk.

Certifications :



*Included Memory Controller
Displays height on left
Easy up and down arrows
Save up to 3 set heights



BOOST+ HEIGHT ADJUSTABLE

BOOST+ BACK TO BACK DESK

The Boost+ Single Desk comes in 3 widths in our standard range of melamine colours. All tops come with a scalloped edge for cable access. Choose to add on a cable tray, a screen or both.

Product Code	Screen	Cable Tray	Width
B+2P1275	No	No	1200mm
B+2P1575	No	No	1500mm
B+2P1875	No	No	1800mm
B+2PCT1275	No	Yes	1200mm
B+2PCT1575	No	Yes	1500mm
B+2PCT1875	No	Yes	1800mm
B+2PWS1275	Yes	No	1200mm
B+2PWS1575	Yes	No	1500mm
B+2PWS1875	Yes	No	1800mm
B+2PWSCT1275	Yes	Yes	1200mm
B+2PWSCT1575	Yes	Yes	1500mm
B+2PWSCT1875	Yes	Yes	1800mm

Top Options :



Frame Finishes :



Screen Finishes :

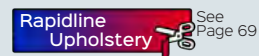
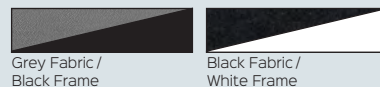

Certifications :



Natural White top with White Frame
Corner workstation

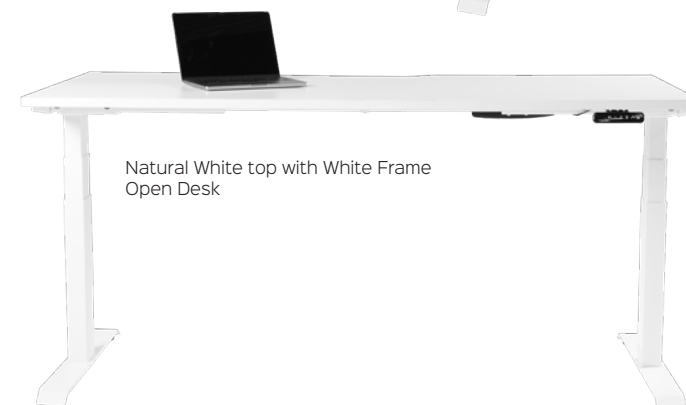

Natural White top with White Frame
Open Desk

Natural White top with Black Frame ->
With Screen and Cable tray.



<- Use additional Cable snakes to manage and safely carry cables from the desk to cable tray.



Natural White top with White Frame
Back to Back.
*Pictured chair not included

RAPID FLUX

Specifications :

Top Width	• RF1 - 880mm • RF2 - 950mm
Depth	Overall - 590mm, Top - 415mm
Height	120mm - 500mm
Weight Capacity	25kg on Top

Finish Options :



Features :

- Electric height adjustable solution for fixed desk
- 22mm per second speed
- Hidden motor makes for a compact design
- Grommet Hole in Worktop for Use with Monitor Arms

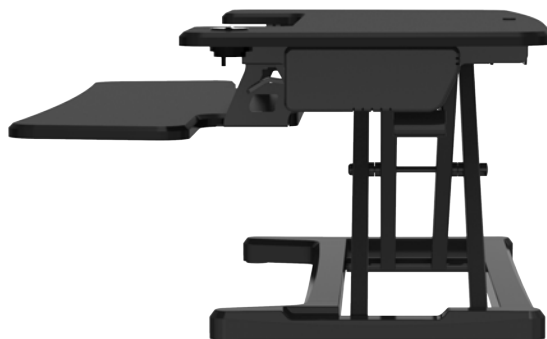
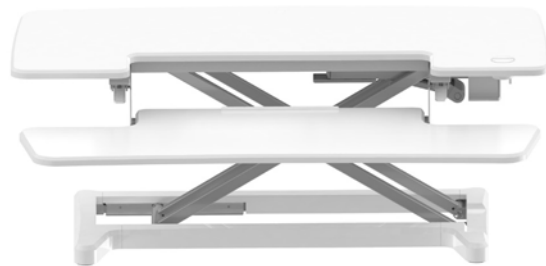

RAPID RISER

Specifications :

Top Width	• RR1 - 680mm • RR2 - 890mm
Top Depth	590mm
Height	150mm - 500mm
Weight Capacity	15kg Weight Capacity on RR1 18kg Weight Capacity on RR2

Finish Options :

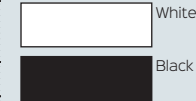

Features :

- Manual height adjustable solution for fixed desk
- 15 Different height level settings
- Comes with hole for monitor arm installation



TRIUMPH MANUAL HEIGHT ADJUSTABLE

Specifications :

Top Width	• TMA127 - 1200mm • TMA157 - 1500mm • TMA187 - 1800mm
Top Depth	700mm
Height	715-1015mm
Weight Capacity	100kg on Top

Top Finishes :



Frame :



Features :

- Manual height adjustable desk
- Universal left or right hand side crank handle
- Intergrated cable dump tray



RAPID REFRESH MAT - RRM BL

Specifications :

Width	900mm
Depth	600mm
Thickness	19mm
Weight	2.4kg

Features :

- Anti-fatigue mat
- 100% PU material
- Use with any height adjustable solution
- Updated Design

Top Finishes :

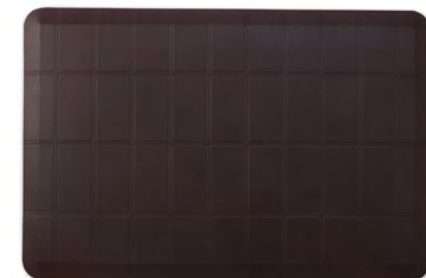
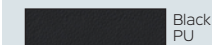

MONITOR ARMS

EXECUTIVE SINGLE MONITOR ARM - ESMARM

Specifications :

Tilt Range	-85° to 15°
Screen Size	17" to 27"
Vesa Size	75 x 75mm or 100 x 100mm
Weight Limit	Min. 2kg - Max 9kg
Fixing	Clamp and Grommet Fix Kit

Finish Options :



Features :

- Gas spring single monitor arm with effortless rotating, pivoting and extendable adjustments.



REVOLVE SINGLE MONITOR ARM - RMA1 BL

Specifications :

Arm Reach	435mm
Pole Height	392mm
Height	200-340mm
Weight Limit	10kg
Movement Range	-85° to 15°

Finish Options :



Features :

- Pole mounted single monitor arm with 200-340mm height range and cable management within.



ELEVATE SINGLE MONITOR ARM - ELEVATE

Specifications :

Forward Range	500mm
Vertical Range	180-480mm
Size Limit	Up to 24 Inch Monitor
Weight Limit	Min. 2kg - Max 8kg
Movement Range	180°

Finish Options :



Features :

- Single swivel monitor arm with 180-480mm height range, 180° degree adjustment and clamp fix kit.



EXECUTIVE DUAL MONITOR ARM - EDMARM

Specifications :

Tilt Range	-85° to 15°
Screen Size	17" to 27"
Vesa Size	75 x 75mm or 100 x 100mm
Weight Limit	Min. 2kg - Max 9kg per Arm
Fixing	Clamp and Grommet Fix Kit

Finish Options :



Features :

- Gas spring dual monitor arms with effortless rotating, pivoting and extendable adjustments.



REVOLVE DUAL MONITOR ARM - RMA2 BL

Specifications :

Arm Reach	360mm per Arm
Pole Height	450mm
Height	260-360mm
Weight Limit	10kg per Arm
Movement Range	-85° to 15°

Finish Options :

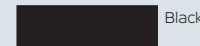

Features :

- Pole mounted dual monitor arm with 260-360mm height range and cable management within, in black finish.



REVOLVE QUAD MONITOR ARM - RMA4 BL

Specifications :

Arm Reach	360mm per Arm
Pole Height	708mm
Height	200-660mm
Weight Limit	10kg per Arm
Movement Range	-85° to 15°

Finish Options :

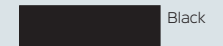

Features :

- Pole mounted quad monitor arm with 200-660mm height range and cable management within, in black finish.



RAPID SCREEN STRAIGHT PODS



RAPID SCREEN CORNER PODS

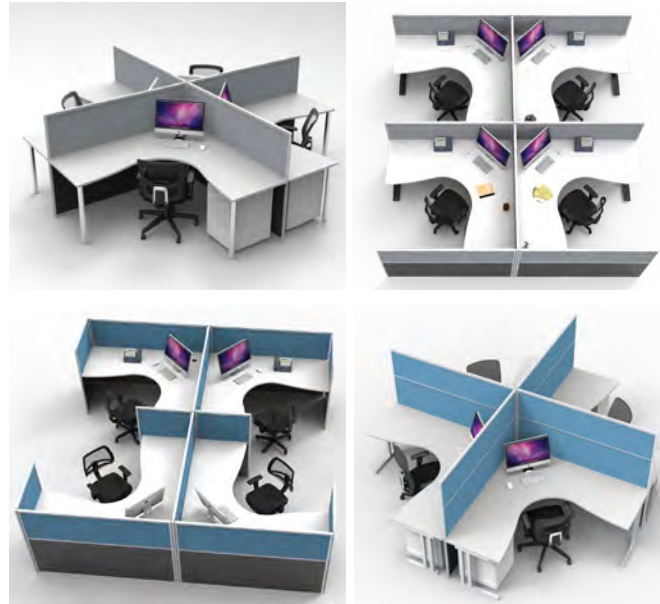

RAPID SCREEN 120° DEGREE PODS



Create a layout to suit your space with a huge selection of tops, legs, and colours to choose from.

Components :

Top Options	Beech or Natural White with cable entry holes T127 - 1200mm W x 700mm D T157 - 1500mm W x 700mm D T187 - 1800mm W x 700mm D
Screen Options	Blue or Grey fabric with ironstone bottom SC712 - 750mm W x 1250mm H x 30mm T SC1212 - 1200mm W x 1250mm H x 30mm T SC1512 - 1500mm W x 1250mm H x 30mm T SC1812 - 1800mm W x 1250mm H x 30mm T SC716 - 750mm W x 1650mm H x 30mm T SC1216 - 1200mm W x 1650mm H x 30mm T SC1516 - 1500mm W x 1650mm H x 30mm T SC1816 - 1800mm W x 1650mm H x 30mm T
Leg Options	DC60 - Round leg in Chrome, Black or White SPLEG - Span leg in Silver, Black or White C LEG - C Leg in Silver only
Joining Pole	Precious Silver SC12/90 - 90° Degree Pole for 1200mm Height SC16/90 - 90° Degree Pole for 1600mm Height

Encourage teamwork while providing privacy.

Components :

Top Options	Beech or Natural White with cable entry hole T1515 - 1500mm x 1500mm, 700mm Top Depth T1812 - 1800mm x 1200mm, 700mm Top Depth T1815 - 1800mm x 1500mm, 700mm Top Depth T1818 - 1800mm x 1800mm, 700mm Top Depth
Screen Options	Blue or Grey fabric with ironstone bottom SC712 - 750mm W x 1250mm H x 30mm T SC1212 - 1200mm W x 1250mm H x 30mm T SC1512 - 1500mm W x 1250mm H x 30mm T SC1812 - 1800mm W x 1250mm H x 30mm T SC716 - 750mm W x 1650mm H x 30mm T SC1216 - 1200mm W x 1650mm H x 30mm T SC1516 - 1500mm W x 1650mm H x 30mm T SC1816 - 1800mm W x 1650mm H x 30mm T
Leg Options	DC60 - Round leg in Chrome, Black or White SPLEG - Span leg in Silver, Black or White C LEG - C Leg in Silver only
Joining Pole	Precious Silver SC12/90 - 90° Degree Pole for 1200mm Height SC16/90 - 90° Degree Pole for 1600mm Height

Spacious workstations per user while still providing sufficient privacy.

Components :

Top Options	Beech or Natural White with cable entry hole T1212-12-7 - 120° Degree Top 1200mm W x 1200mm W x 700mm D
Screen Options	Blue or Grey fabric with ironstone bottom SC712 - 750mm W x 1250mm H x 30mm T SC1212 - 1200mm W x 1250mm H x 30mm T SC716 - 750mm W x 1650mm H x 30mm T SC1216 - 1200mm W x 1650mm H x 30mm T
Leg Options	DC60 - Round leg in Chrome, Black or White SPLEG - Span leg in Silver, Black or White C LEG - C Leg in Silver only
Joining Pole	Precious Silver SC12/120 - 120° Degree Pole for 1200mm Height SC16/120 - 120° Degree Pole for 1600mm Height

Certifications :



RAPID SCREEN COMPONENTS

CHOOSE YOUR TABLE TOP

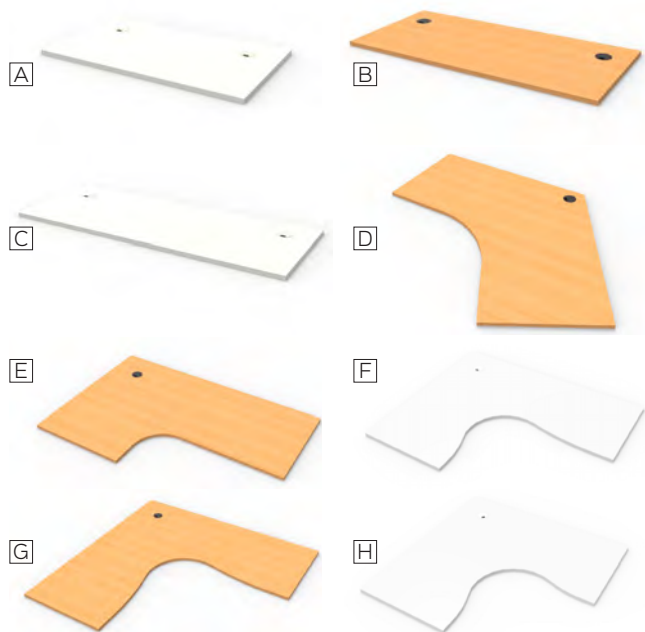

Specifications :

Key	Code	Width	Depth	Thickness
A	T127	1200mm	700mm	25mm
B	T157	1500mm	700mm	25mm
C	T187	1800mm	700mm	25mm
D	T1212-12-7	1200 x 1200mm	700mm	25mm
E	T1812	1800 x 1200mm	700mm	25mm
F	T1815	1800 x 1500mm	700mm	25mm
G	T1818	1800 x 1800mm	700mm	25mm
H	T1515	1500 x 1500 mm	700mm	25mm

Finish Options :



Certifications :



The Rapid Screen system allows ultimate flexibility to suit your space. Different top shapes and sizes, screen heights, leg options and storage choices allow for personalised workstation design.

CHOOSE YOUR LEG STYLE



Specifications :

Key	Code	Description	Dimensions	Qty
I	SPLEG	Span Leg	560W x 705H	2
J	DC60	Round Leg	60 Dia. x 705H	4
K	CLEG	C Leg	550W x 705H	2

Finish Options :

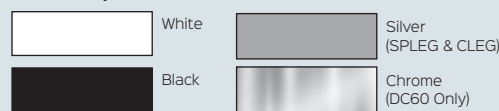

Certifications :



JOINING POLES



Specifications :

Key	Code	Description	Dimensions
L	SC12/90	Join screens at 90°	30 Dia. x 1250 H
L	SC12/120	Join screens at 120°	30 Dia. x 1250 H
M	SC16/90	Join screens at 90°	30 Dia. x 1650 H
M	SC16/120	Join screens at 120°	30 Dia. x 1650 H

Finish :

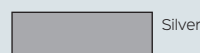

Certifications :



CHOOSE YOUR SCREEN

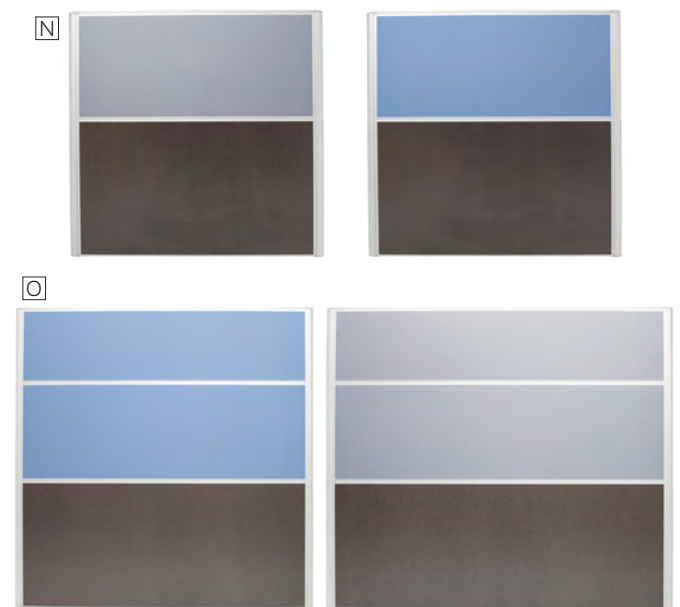

Specifications :

Key	Code	Width	Depth	Height
N	SC1212	1200mm	30mm	1250mm
-	SC1512	1500mm	30mm	1250mm
-	SC1812	1800mm	30mm	1250mm
-	SC712	750mm	30mm	1250mm
-	SC1216	1200mm	30mm	1650mm
O	SC1516	1500mm	30mm	1650mm
-	SC1816	1800mm	30mm	1650mm
-	SC716	750mm	30mm	1650mm

Finish Options :

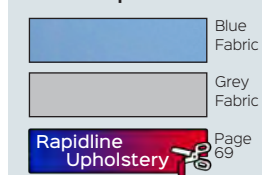

Certifications :



Rapidline Upholstery

Page 69

Features :

- Fabric top half can be upholstered in a range of Rapidline Upholstery fabrics with an additional lead time and cost

CHOOSE YOUR SCREEN ACCESSORIES

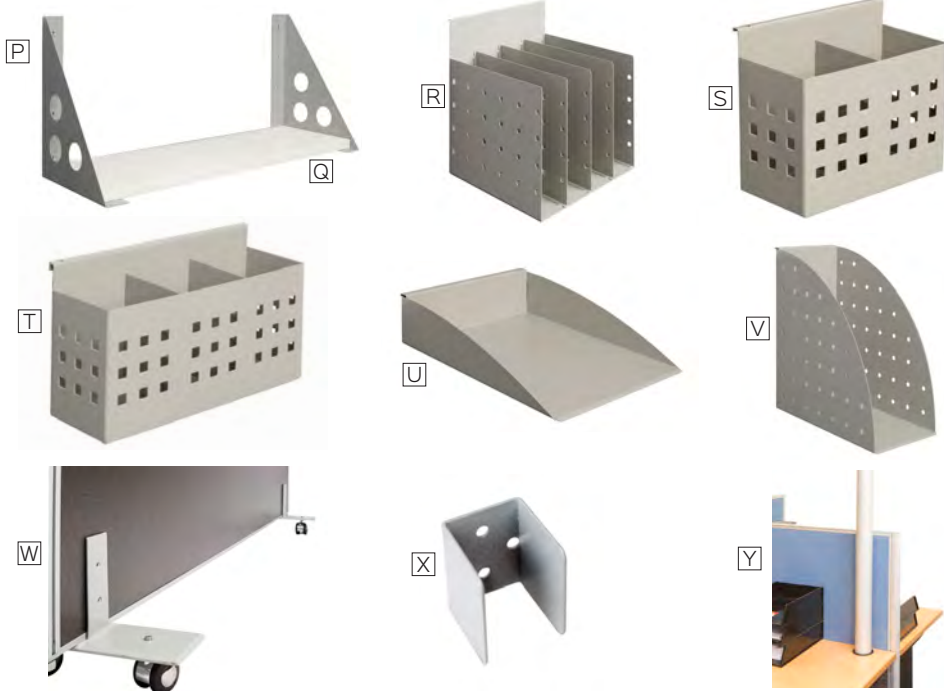

Specifications :

Key	Code	Description	Colour
P	SCSHELF BRACKET	Shelf Brackets	Silver
Q	SCSHELF	900mm W Shelf	Natural White or Beech
R	SCDOC DIVIDE	4 Space Document Divider	Silver
S	SCPENHOLDER 2	Double Pen Holder	Silver
T	SCPENHOLDER 3	Triple Pen Holder	Silver
U	SCDOCTRAY	A4 Document Tray	Silver
V	SCFILE HOLDER	File Holder	Silver
W	SCFREE STANDING FEET	Free Standing Detachable Castor Feet	Silver
X	SCWALLBRACKET	Wall to Screen Starter Bracket	Silver
Y	SW2.1 POWER POLE or SW2.8 POWER POLE	Power Pole Available in 2100mm or 2800mm Height	Silver

Finish :

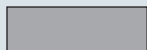

Silver

Shelf Finish Options :



Natural White



Beech

Certifications :



DELUXE RAPID SPAN

STRAIGHT DESKS



RSD1275M WNO
White Frame
Natural Oak Top with Scalloped Edge



RSD1575M SNO
Silver Frame
Natural Oak Top with Scalloped Edge



RSD1875M BNO
Black Frame
Natural Oak Top with Scalloped Edge

CORNER WORKSTATIONS



RSCWS181275M WNO
1800 x 1200mm Corner Top | White Frame
Natural Oak Top with Single Cable Entry Hole



RSCWS181575M SNO
1800 x 1500mm Corner Top | Silver Frame
Natural Oak Top with Single Cable Entry Hole



RSCWS181875M BNO
1800 x 1800mm Corner Top | Black Frame
Natural Oak Top with Single Cable Entry Hole

Deluxe Rapid Span - 750mm Deep desk top in Natural Oak or Natural White finish. Top matches Deluxe Infinity Storage.

The Span range of desking can be configured in back to back desk layouts and pods of workstations as well as stand alone desks. Contact us today for more information.

Desk Size Options :

Product Code	Width	Top Depth	Height
RSD1275M	1200mm	750mm	730mm
RSD1575M	1500mm	750mm	730mm
RSD1875M	1800mm	750mm	730mm

Corner Workstation Size Options :

Product Code	Width	Top Depth	Height
RSCWS181275M	1800 x 1200mm	750mm	730mm
RSCWS151575M	1500 x 1500mm	750mm	730mm
RSCWS181575M	1800 x 1500mm	750mm	730mm
RSCWS181875M	1800 x 1800mm	750mm	730mm

Top Finish :

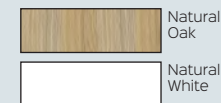

Certifications :



Frame Finishes :

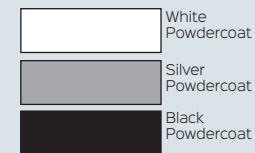

Features :

- Sturdy powdercoated frame and legs
- Comes with metal perforated modesty panel
- Range of sizes to choose from to suit your space
- E0 Melamine top
- Pre cut cable entry hole or scalloped edge
- 750mm Deep top for more workspace
- Hidden cable tidy in legs
- Adjustable feet
- Use with Deluxe Infinity storage. (See page 21)

STRAIGHT DESKS



RSD187M WNW
White Frame
Natural White Top with Cable Entry Holes



RSD187M SB
Silver Frame
Beech Top with Cable Entry Holes



RSD187M BNW
Black Frame
Natural White Top with Cable Entry Holes

CORNER WORKSTATIONS



RSCWS1818M BB
Corner Workstation | Black Frame
Beech Top with Single Cable Entry Hole



RSCWS1818M SNW
Corner Workstation | Silver Frame
Natural White Top with Single Cable Entry Hole



RSDR1818M WB
Desk and Return | White Frame
Beech Top with Cable Entry Holes

Rapid Span Desks - Mix and match colours and sizes.

The Rapid Span range of desking can be configured in back to back desk layouts and pods of workstations as well as stand alone desks. All desks and corner workstations are 700mm deep.

Contact us today for more information.

Desk Size Options :

Product Code	Width	Depth	Height
RSD1277M	1200mm	700mm	730mm
RSD1577M	1500mm	700mm	730mm
RSD1877M	1800mm	700mm	730mm

Corner Workstation Size Options :

Product Code	Width	Depth	Height
RSCWS18127M	1800 x 1200mm	700mm	730mm
RSCWS15157M	1500 x 1500mm	700mm	730mm
RSCWS18157M	1800 x 1500mm	700mm	730mm
RSCWS18187M	1800 x 1800mm	700mm	730mm

Desk with Return Size :

Product Code	Width	Depth	Height
RSDR1818M	1800mm x 1800mm (1100 x 600mm D Return)	700mm	730mm

Top Finishes :

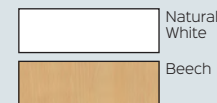

Natural White

Beech

Frame Finishes :

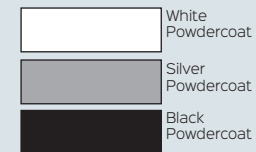

White Powdercoat

Silver Powdercoat

Black Powdercoat

Certifications :



Features :

- Mix and match choice of 2 top colours and 3 frame colours
- E0 Melamine top with pre cut cable entry hole
- Sturdy powdercoated frame and legs
- Comes with metal perforated modesty panel
- Range of sizes to choose from to suit your space
- Pre cut cable entry holes
- 700mm Deep top to suit smaller spaces (600mm D return in RSD1818M)
- Hidden cable tidy in legs
- Adjustable feet

RAPID SPAN STORAGE

RAPID SPAN CUPBOARD - SP2FD18

Specifications :

Width	900mm
Depth	450mm
Height	1800mm

Features :

- Includes 1 x fixed mid shelf
- 3 x adjustable shelves
- Soft close hinges
- Fully lockable with 2 keys included
- E0 Melamine board

Finish Options :

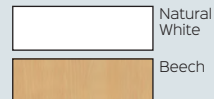

Certifications :



RAPID SPAN BOOKCASE

Specifications :

Width	900mm
Depth	315mm
Height	• SPBC12 - 1200mm
Options	• SPBC18 - 1800mm

Features :

- E0 Melamine board
- 1200mm H comes with 3 x adjustable shelves, 1800mm H comes with 4 x adjustable shelves.

Finish Options :



Certifications :



RAPID SPAN CREDENZA

Specifications :

Width	• SPC12 - 1200mm
Options	• SPC18 - 1800mm
Depth	450mm
Height	730mm

Features :

- Sliding door credenza
- Includes 2 x adjustable shelves
- Fully lockable with 2 keys included
- E0 Melamine board

Finish Options :

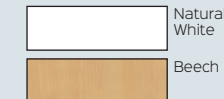

Certifications :



UNDER DESK STORAGE - SPMP3

Specifications :

Width	447mm
Depth	465mm
Height	690mm
Weight Rating	30kg per Drawer

Features :

- Melamine mobile pedestal on castors
- 2 x personal drawers and 1 x file drawer
- Lockable with key, 2 keys supplied
- E0 Melamine board

Top Finishes :

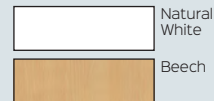

Certifications :



RAPID SPAN HUTCH

Specifications :

Width	• SPH12 - 1200W - 2 Vertical sections
Options	• SPH18 - 1800W - 3 vertical sections
Depth	315mm
Height	1070mm

Features :

- Includes adjustable shelves
- Sits on top of credenza
- Provides extra storage space
- E0 Melamine board

Finish Options :

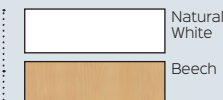

Certifications :





RAPID WORKER

RAPID WORKER STRAIGHT DESK

Specifications :

Top Size Options	<ul style="list-style-type: none"> • CDK96 - 900mm W x 600mm D • CDK126 - 1200mm W x 600mm D • CDK1575 - 1500mm W x 750mm D • CDK1875 - 1800mm W x 750mm D • CDK189 - 1800mm W x 900mm D
Height	730mm

Features :

- E0 Melamine board
- CDK96 with 1 Cable entry hole, all other sizes with 2 cable entry holes
- Modesty panel
- Can be used with fixed pedestals
- Can be used with return to create more work surface area

Finish Options :

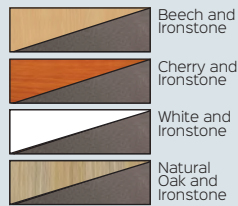

Certifications :



RAPID WORKER DESK RETURN

Specifications :

Desk Return	• CR45 - 900mm W x 450mm D
Size Options	<ul style="list-style-type: none"> • CR6 - 900mm W x 600mm D • CR12 - 1200mm W x 600mm D (Beech & Cherry Only)
Height	730mm

Features :

- E0 Melamine board
- Add to straight desk to create a return
- Creates more desk top space
- Includes modesty panel piece

Finish Options :

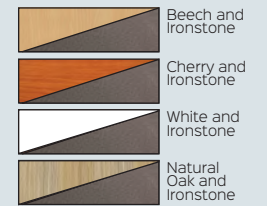

Certifications :



RAPID WORKER CORNER WORKSTATION

Specifications :

Desk Size Options	• RWCWS1212 - 1200 x 1200mm	• RWCWS1215 - 1200 x 1500mm
	• RWCWS1218 - 1200 x 1800mm	• RWCWS1221 - 1200 x 2100mm
	• RWCWS1515 - 1500 x 1500mm	• RWCWS1815 - 1800 x 1500mm
	• RWCWS1818 - 1800 x 1800mm	• RWCWS2115 - 2100 x 1500mm
	• RWCWS2118 - 2100 x 1800mm	• RWCWS2121 - 2100 x 2100mm
Height	730mm	
Depth	600mm (or 750mm in 1800 x 1800mm* In Beech and Cherry only)	

Finish Options :

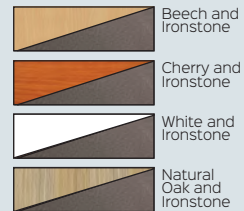

Features :

- 3-piece corner workstation
- Huge range of sizes to suit your space
- Cable entry hole in corner piece
- Modesty panels with space for cable access

Certifications :



RAPID WORKER FIXED PEDESTAL

Options :

CDKP1D1F	1 Drawer and 1 File Drawer 465W x 447D x 454H
CDKP3D	3 Drawers 465W x 447D x 454H
CRP3D	3 Drawers (For Return) *In Ironstone only 465W x 370D x 454H

Finish Options :



Features :

- Install on Right or Left side of Desk
- E0 Melamine board
- Lockable, 2 keys supplied

Certifications :



*Beech / Ironstone
1500 x 1500mm



*Cherry / Ironstone
1800 x 1800mm



*Natural Oak / Ironstone
1800 x 1800mm



*CRP3D Return Fixed Pedestal
Pictured on a Natural White Return



CUPBOARD - CSC2FD

Specifications :

Width	900mm
Depth	450mm
Height	1800mm

Finish Options :



Features :

- 3 x adjustable shelves
- 1 x fixed middle shelf
- Fully lockable with 2 keys included

Certifications :



BOOKCASE

Specifications :

Height	• CBC9 - 900mm
	• CBC12 - 1200mm
Width	• CBC18 - 1800mm
	900mm
Depth	315mm

Finish Options :



Features :

- 3 x adjustable shelves in 900 and 1200 H
- 4 x adjustable shelves in 1800 H

Certifications :



LOCKABLE WALL UNIT - CSC2HD

Specifications :

Width	900mm
Depth	450mm
Height	1800mm

Finish Options :



Features :

- Lockable half height storage
- 2 adjustable shelves
- Supplied with 2 keys

Certifications :



FILING CABINET

Specifications :

Width	465mm
Depth	600mm
Height	• C3FC - 998mm
	• C4FC - 1300mm

Finish Options :

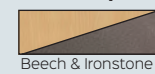

Features :

- Melamine 3 or 4 drawer filing cabinet
- Lockable, supplied with 2 keys
- Metal runner arms

Certifications :



PIGEON HOLE UNIT - PH20

Specifications :

Width	1040mm
Depth	380mm
Height	1040mm

Finish Options :



Features :

- Melamine pigeon hole unit
- 20 slots
- Adjustable shelves

Certifications :



EXTRA SHELVES

Specifications :

CBC SHELF	• 890W x 420D x 25T
	• Use with Bookcases
FD SHELF	• 858W x 405D x 18T
	• Use with Cupboards

Finish Options :

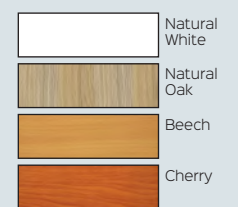

Certifications :



CREDENZA

Specifications :

Width	<ul style="list-style-type: none"> • CMZ1245 - 1200mm • CMZ1545 - 1500mm • CMZ1845 - 1800mm
Depth	450mm
Height	730mm

Features :

- E0 Melamine board
- 2 x adjustable shelves
- Fully lockable sliding door with 2 keys

Certifications :



Finish Options :

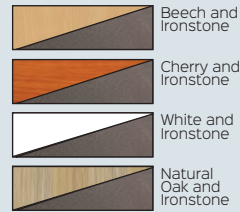

NEW

RAPID WORKER HUTCH

Specifications :

Width	<ul style="list-style-type: none"> • CH12 - 1200mm • CH15 - 1500mm • CH18 - 1800mm
Depth	315mm
Height	1070mm

Features :

- 4 shelves in 1200mm and 1500mm sizes
- 6 shelves in 1800mm size
- E0 Melamine board

Certifications :



Finish Options :

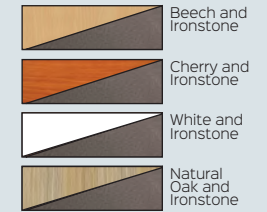

NEW

RAPID WORKER MOBILE PEDESTAL

Specifications :

CMP2F	2 Drawers
CMP2D1F	2 Drawers and 1 File Drawer
CMP4D	4 Drawers
Size	447mm x 465mm x 690mm

Features :

- Drawers with metal runners
- Key locking - 2 keys supplied

Certifications :



Finish Options :

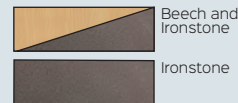

NEW

*CMP4D
4 Drawers



NEW

*CMP2F
2 Filing Drawers



*CMP2D1F
2 Drawers, 1 File Drawer

RAPID WORKER DESK HOB

Specifications :

CHOB15N	• 1500W x 350D
CHOB18N	• 1800W x 350D
Height	400mm

Features :

- Creates a reception counter or privacy for your straight or corner desk

Certifications :



Finish Options :

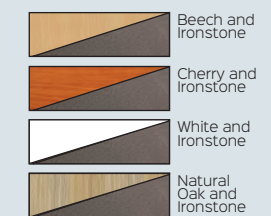

NEW

RAPID VIBE LAPTOP DESK - CDK96

Specifications :

Width	900mm
Depth	600mm
Height	730mm

Finish Options :

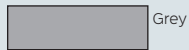

Certifications :



Features :

- E0 Melamine open desk
- Compact size for laptop or hot desk
- Matching under desk modesty panel



RAPID VIBE OPEN DESK

Specifications :

Top Size	• CDK126 - 1200W x 600D
Options	• CDK1575 - 1500W x 750D
	• CDK189 - 1800W x 900D
Height	730mm

Finish Options :

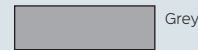

Certifications :



Features :

- E0 Melamine open desk
- Matching under desk modesty panel
- Use with Desk Return for more workspace and to create a corner workstation



RAPID VIBE DESK RETURN - CR6

Specifications :

Width	900mm
Depth	600mm
Height	730mm

Finish Options :

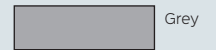

Certifications :



Features :

- E0 Melamine return
- Fix to any straight desk
- Create a corner shaped workstation
- Extra desk top space



RAPID VIBE PEDESTALS

Specifications :

CDKP3D Fixed Pedestal	465W x 447D x 454H 3 Drawers
SPMP3 Mobile Pedestal	447W x 465D x 690H 2 Drawers and 1 File

Finish Options :

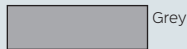

Certifications :



Features :

- Lockable with 2 keys supplied
- Metal runners
- Fifth wheel for stability in Mobile Pedestal
- Silver handles
- E0 Melamine board



RAPID VIBE CORNER WORKSTATION - CWS1818

Specifications :

Overall Width	1800mm x 1800mm
Top Depth	600mm
Height	730mm

Finish Options :

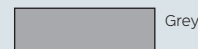

Certifications :



Features :

- E0 Melamine board
- 3 Piece corner workstation
- Under desk modesty panels
- 1 x 80mm cable entry hole in corner



RAPID VIBE DESK HOB - CHOB18N

Specifications :

Width	1800mm
Depth	350mm
Height	400mm

Finish Options :

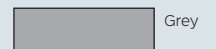

Certifications :



Features :

- Straight edge hob
- Use on straight or corner desk
- Creates a reception counter
- Add privacy to a desk
- E0 Melamine board



RAPID VIBE CUPBOARD - SP2FD18

Specifications :

Width	900mm
Depth	450mm
Height	1800mm

Features :

- Full door cupboard
- 1 x fixed mid shelf
- 3 x adjustable shelves
- Fully lockable with 2 keys included
- E0 Melamine board

Finish Options :

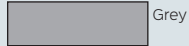

Certifications :



RAPID VIBE BOOKCASE

Specifications :

Width	900mm
Depth	315mm
Height	• SPBC12 - 1200mm • SPBC18 - 1800mm

Features :

- Open bookcase
- 1200mm H with 3 x adjustable shelves
- 1800mm H with 4 x adjustable shelves
- E0 Melamine board

Finish Options :

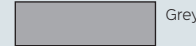

Certifications :



RAPID VIBE HUTCH

Specifications :

Width	• SPH12 - 1200mm • SPH18 - 1800mm
Depth	315mm
Height	1070mm

Features :

- Includes adjustable shelves
- 1200mm W with 2 vertical sections
- 1800mm W with 3 vertical sections
- E0 Melamine board

Finish Options :

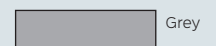

Certifications :



RAPID VIBE CREDENZA

Specifications :

Width	• SPC12 - 1200mm • SPC18 - 1800mm
Depth	450mm
Height	730mm

Features :

- Sliding door credenza
- 2 x adjustable shelves
- Fully lockable with 2 keys included
- E0 Melamine board

Finish Options :

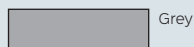

Certifications :



CABLE MANAGEMENT SOLUTIONS

ECHO WIRELESS CHARGER

Specifications :

Width	60mm Diameter
Power	15W Wireless fast charge
ECHOWCTL	500mm TAG lead with L3F splitter
ECHOWCTPP	1500mm 3-pin lead

Finish Options :



Certifications :



Features :

- Wireless fast charging module that can fit into desk top. *Check compatibility with phone brand*



ODYSSEY POWER DOCK

Specifications :

ODYS2G2USBTTP	2 x GPO + 1 x USB A + 1 x USB C + 1500mm 3-pin lead
ODYS4G4USBTTP	4 x GPO + 2 x USB A + 2 x USB C + 1500mm 3-pin lead
ODYS8G4USBTTP	8 x GPO + 2 x USB A + 2 x USB C + 1500mm 3-pin lead

Finish Options :

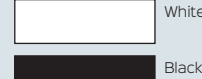

Certifications :



Features :

- The complete power solution for where shared power is needed. Use in boardrooms, conference areas, hot desking or meeting.



ATOM USB CHARGING MODULE

Specifications :

ATOMUSB	2 x USB + 1500mm 3-pin lead
ATOMBRACK	Under Desk & Lounge Mounting Bracket

Finish Options :

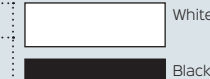

Certifications :



Features :

- USB charging module
- Can be integrated into desk top or fixed underneath desk top, or mounted to lounges with a mounting bracket.



BLINKY POWER POD

Specifications :

Size	Fits in 135mm Diameter cutout
BLKY3GTL	3 x GPO + 500mm TAG lead
BLKY3GTPP	3 x GPO + 1500mm 3-pin lead
BLKY3G3USBTL	3 x GPO + 3 x USB C + 500mm TAG lead
BLKY3G3USBPP	3 x GPO + 3 x USB C + 1500mm 3-pin lead

Features :

- Multi-power pod with different power configurations available
- Sits on desk top

Finish Options :

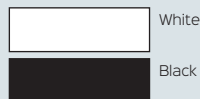

Certifications :



POWER POLE AND UMBILICAL - SW2.1 | SW2.8

Specifications :

Desk to Ceiling	2.1m power pole or umbilical kit for desk to ceiling power
Kit Includes	with ceiling kit, under desk mounting bracket, desk grommet and cover
Floor to Ceiling	2.8m power pole or umbilical kit for floor to ceiling power
Kit Includes	power with ceiling kit, floor bracket and cover

Features :

- Carries cables and wiring to your desk from the ceiling
- Perfect for open plan offices for desks in the centre of the room

Finish Options :

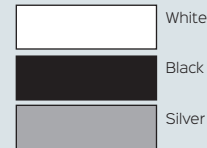

Certifications :



TRAX - SWTD12

Specifications :

Length	1200mm
--------	--------

Finish Options :

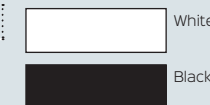

Certifications :



Features :

- Solution for height adjustable desks
- Cable tray to workstation umbilical
- Dual Compartment for power and data
- SWTDMAG - Magnet for fixing to steel bases available for additional cost
- Includes tray base fixing, and under desk bracket



SINGLE TIER CABLE BASKET KIT - SWBK

Specifications :

Available Widths	<ul style="list-style-type: none"> • 650mm for 900mm Desks • 950mm for 1200mm Desks • 1250mm for 1500mm Desks • 1550mm for 1800mm Desks
Available Options	<ul style="list-style-type: none"> • 2 x GPO • 4 x GPO

Finish Options :



Features :

- Under desk cable basket kit to organise cables, for power only. Includes basket, power module, gpo clip and interconnecting lead.



DUAL TIER CABLE BASKET KIT - SWBK

Specifications :

Available Widths	<ul style="list-style-type: none"> • 650mm for 900mm Desks • 950mm for 1200mm Desks • 1250mm for 1500mm Desks • 1550mm for 1800mm Desks
Available Options	<ul style="list-style-type: none"> • 2 x GPO with 2 Data tiles • 4 x GPO with 2, 3 or 4 Data

Finish Options :



Features :

- Under desk cable basket kit to organise cables. Includes basket, power module, gpo clip, interconnecting lead and data tile.



ATHENA POWER RAIL KIT

Specifications :

SWPR2G	2 x Rotated GPO
SWPR2G2USB	2 x GPO + 2 x USB
SWPR2G2D	2 x GPO + 2 Data Provision
SWPR4G3D	4 x GPO + 3 x Data Provision

Finish Options :



Features :

- Includes 500mm Tag Lead D & Splitter
- Clamps onto desk top
- Comes with desk clamps
- Range of configurations to choose from



BOARDROOM TABLE BOX

Specifications :

SWTB2G3D	2 x GPO + 3 Data Provision
SWTB4G5D	4 x GPO + 5 x Data Provision

Finish Options :

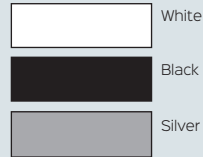

Features :

- Sits in desk or table top
- Lid closes to hide points when not in use
- Leads not included



POP UP POWER

Specifications :

SWPOP2G	2 x GPO
SWPOP1G2USB	1 x GPO + 2 x USB

Finish Options :

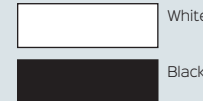

Features :

- Pop up power module
- Offers above desk power, data and USB
- Can be concealed when not in use
- Leads not included



IN DESK MODULE

Specifications :

SWHDP	1 x GPO + 2 x USB + 1 x Data Provision + 500mm TAG lead + 3 way splitter
SWHDP KIT	1 x GPO + 2 x USB + 1 x Data Provision + 500mm TAG lead

Finish Options :



Features :

- In desk module
- Offers above desk power, data and USB
- Fits into 80mm cable entry holes



SMALL MEETING TABLES

ETERNITY ROUND & SQUARE TABLES

Specifications :

Round	• D-ERT9 - 900mm Diameter • D-ERT12 - 1200mm Diameter
Square	• D-ERT990 - 900mm W x 900mm D
Height	730mm

Features :

- Powdercoated base
- Adjustable feet
- 45 degree profile to leg
- E0 Melamine board table top

Top Options :

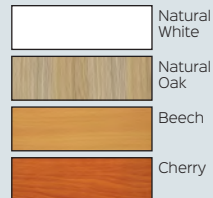

Base Options :



Certifications :



FOUR STAR BASE ROUND TABLE - RSRT | RBRT | RWRT

Specifications :

Top Diameter	• 900mm
Options	• 1200mm
Table Height	730mm

Features :

- 4 star base
- Adjustable feet
- E0 Melamine board table top

Top Options :

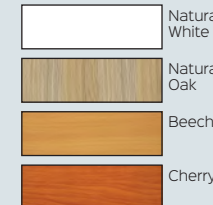

Base Options :

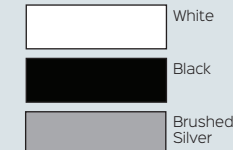

Certifications :



TYPHOON ROUND TABLE

Specifications :

Top Diameter	• TTR9 - 900mm
Options	• TTR12 - 1200mm
Table Height	730mm

Features :

- 4 star black and polished aluminium base
- Adjustable feet
- E0 Melamine board table top

Top Options :

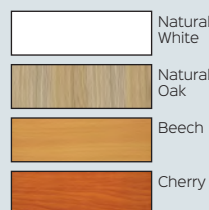

Base :



Certifications :



RAPID AIR ROUND TABLE

Specifications :

Top Diameter	• RART9 - 900mm
Options	• RART12 - 1200mm
Overall Height	750mm

Features :

- Modern tripod polished aluminium base
- Matches Rapid Air boardroom range
- E0 Melamine board table top

Top Options :

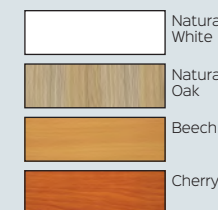

Base :



Certifications :



DISC BASE TABLE

Specifications :

Round	• CBT9 - 900mm Dia. • CBT12 - 1200mm Dia.
Square	• CBT990 - 900W x 900D
Height	755mm

Features :

- Flush flat disc base
- E0 Melamine board table top

Top Options :

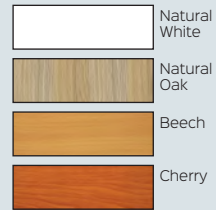

Base Options :

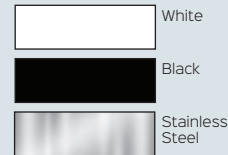

Certifications :



IRONSTONE BASE ROUND TABLE

Specifications :

Top Diameter	• CRM9 - 900mm • CRM12 - 1200mm
Options	
Table Height	730mm

Features :

- Full E0 Melamine board Top and Base
- Solid melamine ironstone base
- Available in 2 sizes and 2 top finishes
- Matches with Rapid Worker range

Top Options :



Certifications :



Base :



STEEL FRAME TABLE

Specifications :

Top Size	• SFT126 - 1200W x 600D
Options	• SFT1575 - 1500W x 750D • SFT1875 - 1800W x 750D • SFT189 - 1800W x 900D
Table Height	730mm

Features :

- Black steel frame
- Adjustable levelling feet
- E0 Melamine board table top

Top Options :

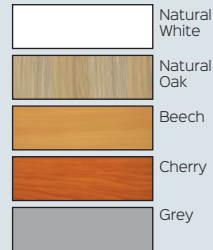

Base :



Certifications :



SILVER FRAME TABLE

Specifications :

Top Size	• RST1875 - 1800W x 750D
Options	• RST189 - 1800W x 900D
Table Height	730mm

Features :

- Stylish angled frame
- Adjustable feet
- E0 Melamine board table top

Top Options :

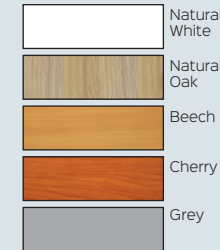

Base :

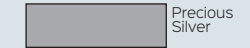

Certifications :



CONVERTIBLE TABLES

TYPHOON FLIP TOP TABLE

Specifications :

Top Width Options	• TFT1575 - 1500mm • TFT1875 - 1800mm
Top Depth	750mm
Table Height	750mm

Features :

- Locking castors
- Easy storage when not in use
- Table links available for extra
- E0 Melamine board table top

Top Options :

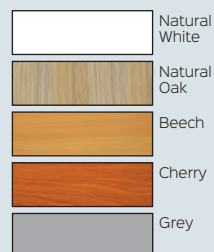

Base :



Certifications :



FOLDING TABLE

Specifications :

Top Size Options	• FFT1575 - 1500W x 750D • FFT1875 - 1800W x 750D • FFT189 - 1800W x 900D
Table Height	730mm

Features :

- Adjustable levelling feet
- Suitable for heavy duty use
- Easy storage when not in use
- Easy to use folding mechanism
- E0 Melamine board table top

Top Options :

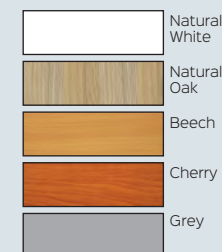

Base :

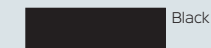

Certifications :



RAPID EDGE FOLDING TABLE - FBT2410

Specifications :

Top Width	2400mm
Top Depth	1000mm
Table Height	743mm

Features :

- Folding table, top folds in half
- Black rubber strip edging
- Quick release mechanism
- Includes 2 x table links

Top Options :

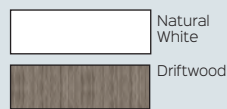

Base :



Certifications :



BUDGET FLIP TOP TABLE

Specifications :

Top Width Options	• FTT1575 - 1500mm • FTT1875 - 1800mm
Top Depth	750mm
Table Height	730mm

Features :

- Padded pull handle
- Locking castors
- Table links available for extra
- E0 Melamine board table top

Top Options :

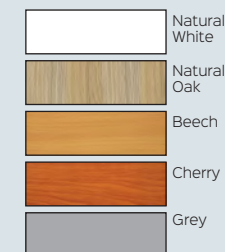

Base :

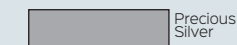

Certifications :



DRY BAR TABLE - CDBT6

Specifications :

Top Size	600mm Diameter
Table Height	1085mm

Features :

- Circular Dry Bar Table
- Flush flat Disc Base
- E0 Enviroboard Top
- Adjustable Levelling Feet
- Mix and Match top and base colours

Top Options :

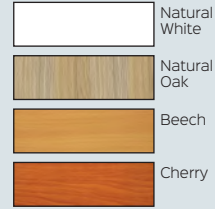

Base Options :

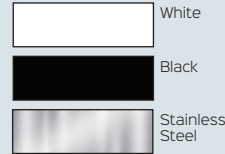

ETERNITY HIGH BAR TABLE

Specifications :

Top Size	• D-EHBT1575 - 1500W x 750D
Options	• D-EHBT1875 - 1800W x 750D
	• D-EHBT189 - 1800W x 900D
Table Height	1050mm

Features :

- Bar height
- Stylish angled leg, matches with Eternity range
- Dual support rails for added stability
- Adjustable feet
- E0 Melamine board table top

Top Options :

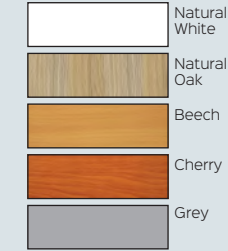

Base :

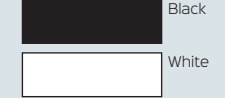

DRAFTING HEIGHT TABLE

Specifications :

Top Size	• 9SFT1575 - 1500W x 750D
	• 9SFT189 - 1800W x 900D
Table Height	900mm

Features :

- Drafting height table
- Powdercoated steel frame
- E0 Melamine board table top
- Adjustable feet

Top Options :

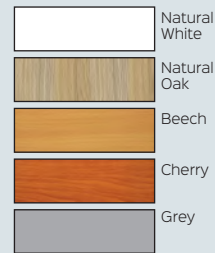

Base :

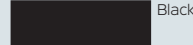

HIGH BAR TABLE - HBT189

Specifications :

Top Width	1800mm
Top Depth	900mm
Table Height	1050mm

Features :

- High bar table
- Powdercoated frame
- Cross bar foot rest
- Adjustable levelling feet
- E0 Melamine board table top

Top Options :

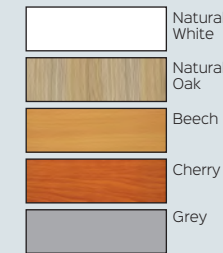

Base :

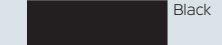

BOARDROOM TABLES

RAPID AIR BOARDROOM TABLE

Specifications :

Size	• RAB2412 - 2400W x 1200D
Options	• RAB3212 - 3200W x 1200D
Height	750mm

Features :

- Suspended floating top
- Available with single or dual stage frame
- 1-Piece Top for 2400mm size
- 2-Piece Top for 3200mm size
- E0 Melamine board table top

Certifications :



Top Options :

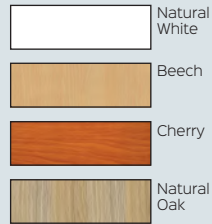

Base :



TYPHOON BOARDROOM TABLE

Specifications :

Size	• TTR189 - 1800W x 900D
Options	• TTR2412 - 2400W x 1200D
	• TTR3212 - 3200W x 1200D
Height	750mm

Features :

- Available in 3 sizes
- Single or dual stage frame
- E0 Melamine board table top

Certifications :



Top Options :

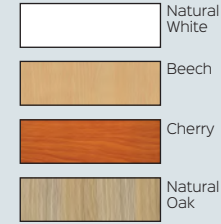

Base :



IRONSTONE BASE BOARDROOM TABLE

Specifications :

Size	• CBT2412 - 2400W x 1200D
Options	• CBT3212 - 3200W x 1200D
Height	730mm

Features :

- Made entirely of E0 Melamine board
- Sturdy H shape base
- 1-Piece Top for 2400mm size
- 2-Piece Top for 3200mm size

Certifications :



Top Options :



Base :

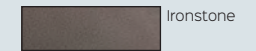

Rapid Air Boardroom
Cherry Top
2400mm x 1200mm



Typhoon Boardroom
Beech Top
2400mm x 1200mm



Ironstone Base Boardroom
Natural Oak Top
2400mm x 1200mm



Rapid Air Boardroom
Natural White Top
3200mm x 1200mm



Typhoon Boardroom
Natural White Top
3200mm x 1200mm



Ironstone Base Boardroom
Natural White Top
3200mm x 1200mm

ETERNITY MEETING

Specifications :

Size Options	<ul style="list-style-type: none"> • EMT1575 - 1500W x 750D • EMT1875 - 1800W x 750D • EMT189 - 1800W x 900D
Height	750mm

Features :

- E0 Rated 25mm thick Melamine board
- Double support rails
- Powdercoated base with adjustable feet
- 1-piece top in 3 sizes
- 45 degree profile to leg, matches Eternity workstation range

Top Options :

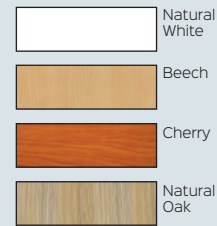

Base :

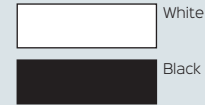

Certifications :



ETERNITY BOARDROOM

Specifications :

Size Options	<ul style="list-style-type: none"> • EMT2412 - 2400W x 1200D • EMT3212 - 3200W x 1200D
Height	750mm

Features :

- E0 Rated 25mm thick Melamine board
- Double support rails
- Powdercoated base with adjustable feet
- 45 degree profile to leg
- Matches Eternity workstation range
- Intermediate leg in the 3200mm table

Top Options :



Base :



Certifications :



Eternity Meeting Table
White Top, White Frame
1500mm x 750mm



Eternity Meeting Table
Cherry Top, Black Frame
1800mm x 750mm



Eternity Meeting Table
Beech Top, White Frame
1800mm x 900mm



Eternity Boardroom
Beech Top, Black Frame
2400mm x 1200mm



Eternity Boardroom
Natural Oak Top, White Frame
3200mm x 1200mm

MESH CHAIRS

MOTION CHAIR - MMC BG

Specifications :

Overall Size	960 - 1050H x 650W x 560D
Seat Size	520W x 510D
Gas Height	440 - 530H
Weight Rating	135kg

Features :

- Donati-dopo weight sensitive mechanism
- Seat slide, lumbar cushion, height adjustable
- 3D adjustable arms
- Head rest available with lead time

Certifications :



Finish Options :



LUMINOUS TASK - LUMINOUS

Specifications :

Overall Size	960 - 1030H x 625W x 500D
Seat Size	480W x 545D
Gas Height	420 - 510H
Weight Rating	135kg

Features :

- High back black mesh executive chair
- Synchro mechanism, adjustable arms
- Height adjustable
- Head rest and hanger available with lead time

Certifications :



Finish Options :



ERGO CHAIR - ERGO TASK

Specifications :

Overall Height	950 - 1040H x 520W x 540D
Seat Size	520W x 490D
Gas Height	450 - 540H
Weight Rating	165kg

Features :

- Fully ergonomic black mesh back chair
- Seat slide and ratchet back
- Suitable for heavy duty use
- Height adjustable

Certifications :



Finish Options :



GESTURE - GTC BK

Specifications :

Overall Size	955 - 1045H x 660W x 550D
Seat Size	480W x 520D
Gas Height	450 - 540H
Weight Rating	130kg

Features :

- Synchro-dynamic mechanism, seat slide
- Synchronised back rest and seat pan tilt
- Adjustable arms and height
- Head rest available with lead time

Certifications :



Finish Options :



ARCO CHAIR - ARCO BL

Specifications :

Overall Size	900 - 1075H x 720W x 580D
Seat Size	510W x 500D
Gas Height	450 - 540H
Weight Rating	135kg

Finish :

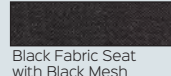

Black Fabric Seat with Black Mesh



Features :

- F020S synchronized mechanism with 4 locking positions, seat slider
- Nylon base on castors
- 3D Adjustable arms
- Height Adjustable

Certifications :



ORCA CHAIR - ORCA BL

Specifications :

Overall Size	1030 - 1120H x 730W x 655D
Seat Size	680W x 575D
Gas Height	460 - 550H
Weight Rating	135kg

Finish :

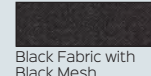

Black Fabric with Black Mesh



Features :

- Black 5 star base on castors
- F020S synchronized mechanism with 4 locking positions
- Seat slider & 3D Adjustable arms
- 80mm thick molded foam seat, mesh back

Certifications :



OASIS CHAIR - OASIS BL

Specifications :

Overall Size	1150 - 1220H x 650W x 620D
Seat Size	490W x 515D
Gas Height	470 - 540H
Weight Rating	135kg

Finish :



Mesh Seat with Mesh Back



Features :

- Height adjustable
- Nylon base on castors
- Mesh back and Mesh seat for ultimate breathability
- Nylon Armrests and Donati Mechanism

Certifications :



HARTLEY CHAIR - HARTLEY TASK

Specifications :

Overall Height	950 - 1015H x 630W x 500D
Seat Size	500W x 480D
Gas Height	440 - 520H
Weight Rating	110kg

Features :

- Synchro mechanism with tension control
- Moulded foam seat, black mesh back
- Adjustable arms, adjustable height
- Head rest available with lead time

Certifications :



Finish Options :



Black Fabric Seat with Black Mesh

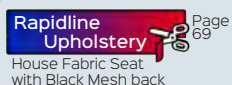

House Fabric Seat with Black Mesh back



*Standard Black Fabric



*Pictured with Spray Fabric, Surface textiles Yarra range



*Pictured with Headrest

KAL TASK CHAIR - KAL TASK

Specifications :

Overall Size	970 - 1030H x 650W x 530D
Seat Size	500W x 510D
Gas Height	430 - 520H
Weight Rating	135kg

Features :

- Lumbar support, synchro mechanism
- Tension control and adjustable arms
- Height adjustable
- Head rest available with lead time

Certifications :



Finish Options :

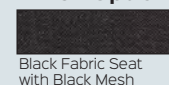

Black Fabric Seat with Black Mesh

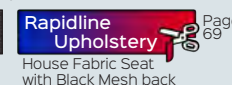

House Fabric Seat with Black Mesh back



*Standard Black Fabric



*Pictured with Spray Fabric, Surface textiles Yarra range



*Pictured With Headrest

MESH CHAIRS

ZOOM CHAIR - ZOOM | ZOOM TABLET

Specifications :

Overall Size	820H x 625W x 590D
Seat Size	490H x 460W x 490D
*Tablet Overall	20H x 420W x 280D
Weight Rating	110kg

Features :

- Mesh back with fabric seat
- Foldable, can be nested when not in use
- *Tablet sold separately
- Seat upholstered in house fabrics for extra

Finish Options :



Black Fabric



Certifications :



*Standard Black, with Tablet arm



*Pictured with Marine Fabric, Surface textiles Yarra range

AM100 CHAIR - AM100

Specifications :

Overall Size	990 - 1080H x 650W x 610D
Seat Size	470W x 490D
Gas Height	460 - 550
Weight Rating	120kg

Features :

- Seat and Back tilt
- Curved black mesh back, black fabric seat
- Adjustable arms
- Height Adjustable

Finish :



Black

Certifications :



VESTA CHAIR - VESTA

Specifications :

Overall Size	870 - 970H x 630W x 630D
Seat Size	460W x 460D
Gas Height	430 - 530H
Weight Rating	90kg

Features :

- Black mesh back chair
- Single Point lock
- Height adjustable
- Fixed arms

Finish :



Black

Certifications :



HARTLEY VISITOR - HARTLEY VISITOR

Specifications :

Overall Size	950H x 645W x 480D
Seat Size	440H x 510W x 480D
Weight Rating	135kg

Features :

- Black cantilever frame chair with adjustable arms as standard
- Black mesh back
- Comfortable padded fabric seat that can be upholstered in our Rapidline Upholstery range
- Matches with Hartley Task Chair

Finish Options :



Black

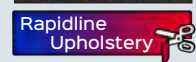

Page 69

Certifications :



*Standard Black seat



*Pictured with Pebble Fabric, Surface textiles Yarra range



*Standard Black

VIENNA CHAIR - VIENNA

Specifications :

Overall Size	980 - 1100H x 610W x 610D
Seat Size	490W x 490D
Gas Height	430 - 550H
Weight Rating	100kg

Features :

- Mesh back available in a range of bright colours
- Height adjustable chair on a 5 star base with castors
- Tilt lock mechanism
- Fixed loop arms

Finish Options :



Black



Blue

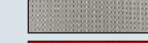

Silver



Red

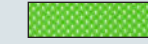

Lime



Certifications :



VIVA CHAIR - VIVA

Specifications :

Overall Size	775 - 875H x 475W x 460W
Seat Size	455W x 430D
Gas Height	425 - 515H
Weight Rating	110kg

Finish Options :
 Black PU / White Frame
 **Rapidline Upholstery** Page 69

Certifications :

Features :

- Stylish white polypropylene shell
- Height adjustable
- White base with black castors
- Black PU seat pad - Rapidline Upholstery available



FOCAL TUB - FOCAL

Specifications :

Overall Size	785H x 570W x 540D
Seat Size	450H x 370W x 380D
Weight Rating	110kg

Finish :
 Charcoal Ash Fabric / Black Base

Certifications :

Features :

- Polypropylene inner shell with foam overlay
- Fixed height
- Powdercoated 4 star base
- Fabric upholstery



PIXEL CHAIR - PIXEL

Specifications :

Overall Size	850H x 485W x 600D
Seat Size	430H x 480W x 460D
Weight Rating	110kg

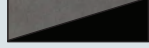
Finish :
 Grey Fabric / Black Frame

Certifications :

Features :

- Ribbed stitching detail
- Solid timber inner frame with foam overlay
- Fixed height, swivel, 4 star base
- *Arms available for additional cost





MILAN CHAIR - MILAN MB BL

Specifications :

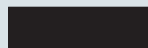
Overall Size	1040 - 1105H x 510W x 480W
Seat Size	510W x 480D
Gas Height	490 - 555H
Weight Rating	160kg

Finish :
 Black Plastic / Black Fabric

Certifications :
 

Features :

- Height Adjustable Ratchet Mesh Back
- Fully Ergonomic 4 Lever Mechanism With Seat Slide
- Heavy Duty Base With 50mm Hard Floor Castors
- Luxurious Heavy Duty Moulded Foam Seat





NEW

WM600 CHAIR - WM600

Specifications :

Overall Size	900 - 1020H x 580W x 530D
Seat Size	510W x 420D
Gas Height	480 - 590H
Weight Rating	120kg

Finish :
 Black Mesh / Aluminium Base

Certifications :
 

Features :

- Ideal meeting chair
- Polished aluminium base and arms
- Single point tilt lock
- Height adjustable



RE100 CHAIR - RE100

Specifications :

Overall Size	1020 - 1140H x 510W x 500W
Seat Size	510W x 500D
Gas Height	470 - 590H
Weight Rating	110kg

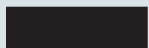
Finish :
 Black Plastic / Black Fabric

Certifications :

Features :

- Plastic perforated back with fixed arms
- Single point tilt lock
- Height adjustable
- Black base with black castors



EXECUTIVE CHAIRS

CL410 CHAIR - CL410

Specifications :

Overall Size	1190 - 1290H x 650W x 720D
Seat Size	540W x 500D
Gas Height	450 - 550H
Weight Rating	120kg

Finish :



Black PU / Chrome Frame

Certifications :



Features :

- Soft black PU upholstery with fabric inlay
- Infinite tilt lock, height adjustable
- Fixed curved arm rests
- Chrome base



CL610 CHAIR - CL610

Specifications :

Overall Size	1010 - 1140H x 620W x 680D
Seat Size	495W x 500D
Gas Height	450 - 580H
Weight Rating	120kg

Finish :

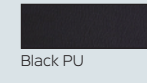

Black PU

Certifications :



Features :

- Soft black PU upholstery
- Single point tilt lock, height adjustable
- Medium back
- Fixed curved arm rests



CL710 CHAIR - CL710

Specifications :

Overall Size	1230 - 1320H x 630W x 600D
Seat Size	530W x 530D
Gas Height	460 - 550H
Weight Rating	120kg

Finish :

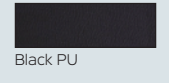

Black PU

Certifications :



Features :

- Soft black PU upholstery
- 4 point tilt lock, height adjustable
- High back executive chair
- Fixed curved armrests



CL820 CHAIR - CL820

Specifications :

Overall Size	1180 - 1250H x 670W x 740D
Seat Size	520W x 480D
Gas Height	420 - 490H
Weight Rating	130kg

Finish :



Black PU / Chrome Frame

Certifications :



Features :

- Soft black PU upholstery
- Infinite tilt lock, height adjustable
- Fixed curved polished aluminium arms
- Chrome base



PU900 MEDIUM - PU900M

Specifications :

Overall Size	890 - 960H x 580W x 530D
Seat Size	520W x 435D
Gas Height	460 - 545H
Weight Rating	120kg

Finish :



Black PU / Chrome Frame

Certifications :



Features :

- Medium back upholstered in Black PU
- Single point lock, height adjustable
- Polished aluminium base
- Fixed arms



PU900 HIGH - PU900H

Specifications :

Overall Size	1050 - 1135H x 585W x 530D
Seat Size	500W x 415D
Gas Height	460 - 550H
Weight Rating	120kg

Finish :



Black PU / Chrome Frame

Certifications :



Features :

- High back upholstered in Black PU
- Single point lock, height adjustable
- Polished aluminium base
- Fixed arms



PU300 CHAIR - PU300

Specifications :

Overall Size	1090 - 1170H x 670W x 640D
Seat Size	540W x 450D
Gas Height	510 - 590H
Weight Rating	130kg

Finish :



Black PU / Chrome Frame

Certifications :



Features :

- Fully ergonomic soft black pu chair
- Ratchet back, seat slide, height adjustable
- Chrome base
- Adjustable arms



PU605 MEDIUM - PU605M

Specifications :

Overall Size	980 - 1030H x 580W x 510D
Seat Size	485W x 460D
Gas Height	490 - 610H
Weight Rating	120kg

Finish Options :



Black PU / Chrome Frame



Tan PU / Black Frame



Black PU / Black Frame

Features :

- Medium back executive chair
- Infinite lock, height adjustable
- Polished aluminium / powdercoated base



PU605 HIGH - PU605H

Specifications :

Overall Size	1105 - 1240H x 580W x 510D
Seat Size	485W x 460D
Gas Height	490 - 610H
Weight Rating	120kg

Finish :



Black PU / Chrome Frame

Certifications :



Features :

- High back black PU executive chair
- Infinite lock, Height adjustable
- Polished aluminium base
- Fixed chrome arms



CL3000 HIGH BACK - CL3000H

Specifications :

Overall Size	1200 - 1320H x 620W x 540D
Seat Size	505W x 510D
Gas Height	440 - 560H
Weight Rating	120kg

Finish :



Black PU / Aluminium Frame

Certifications :



Features :

- High back slimline black PU executive chair • Seat and back tilt, height adjustable
- 3-position lock mechanism with anti shock
- Fixed arm rests



CL3000 MEDIUM BACK - CL3000M

Specifications :

Overall Size	1000 - 1130H x 620W x 555D
Seat Size	505W x 510D
Gas Height	440 - 560H
Weight Rating	120kg

Finish :



Black PU / Aluminium Frame

Certifications :



Features :

- Medium back slimline black pu executive chair
- Seat and back tilt, height adjustable
- 3-position lock mechanism with anti shock
- Fixed arm rests



CL3000 VISITOR - CL3000V

Specifications :

Overall Size	1000H x 590W x 540D
Seat Size	460H x 510W x 510D
Weight Rating	120kg

Finish :



Black PU / Aluminium Frame

Certifications :



Features :

- Slimline executive visitor chair
- Soft black PU seat and back
- Fixed, chrome upholstered arms
- Cantilever base



OPERATOR CHAIRS

ENDEAVOUR CHAIR - ENDEAVOUR PRO BL

Specifications :

Overall Size	1040 - 1105H x 510W x 480D
Seat Size	510W x 480D
Gas Height	490 - 555H
Weight Rating	160kg

Finish :

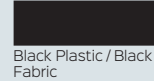

Features :

- 4 Lever Heavy Duty Mechanism With Seat Slide
- Heavy Duty Base With 50mm Hard Floor Castors
- Triple Strip Lumbar Support
- Luxurious Heavy Duty Moulded Foam Seat

Certifications :



NEW

EG400 CHAIR - EG400

Specifications :

Overall Size	960 - 1080H x 510W x 520D
Seat Size	520W x 480D
Gas Height	480 - 620H
Weight Rating	130kg

Finish Options :



Features :

- AFRDI level 6
- Fully ergonomic high, square back, fabric chair
- injection moulded foam seat
- Seat and back tilt with gas lift

Certifications :



EC070BM CHAIR - EC070BM

Specifications :

Overall Size	900 - 1030H x 500W x 450D
Seat Size	500W x 450D
Gas Height	470 - 600H
Weight Rating	120kg

Finish Options :



Features :

- AFRDI level 6
- Medium back fabric chair
- Back tilt, gas lift
- injection moulded foam seat

Certifications :



SWIFT CHAIR - SWIFT BL

Specifications :

Overall Size	990 - 1090H x 630W x 500D
Seat Size	540W x 450D
Gas Height	510 - 590H
Weight Rating	130kg

Finish :



Features :

- High back black fabric chair
- Infinite tilt lock, Height adjustable
- Polished aluminium spider base
- Adjustable arms

Certifications :



EC070CH CHAIR - EC070CH

Specifications :

Overall Size	990 - 1120H x 500W x 450D
Seat Size	500W x 450D
Gas Height	470 - 600H
Weight Rating	120kg

Finish Options :



Features :

- Fully ergonomic high back fabric chair
- injection moulded foam seat
- Seat and back tilt with gas lift

Certifications :



EC070BH CHAIR - EC070BH

Specifications :

Overall Size	990 - 1120H x 500W x 450D
Seat Size	500W x 450D
Gas Height	470 - 600H
Weight Rating	120kg

Finish Options :

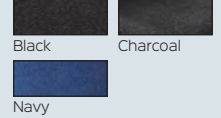

Features :

- High back chair
- Gas lift, back tilt
- Injection moulded foam

Certifications :



EC070CM CHAIR - EC070CM

Specifications :

Overall Size	900 - 1030H x 500W x 450D
Seat Size	500W x 450D
Gas Height	470 - 600H
Weight Rating	120kg

Features :

- AFRDI level 6
- Fully ergonomic medium back fabric chair
- injection moulded foam seat
- Seat and back tilt with gas lift

Certifications :



Finish Options :

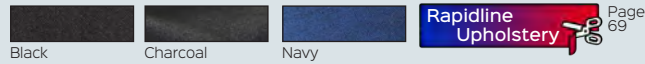

EG100CH CHAIR - EG100CH

Specifications :

Overall Size	1010 - 1150H x 520W x 480D
Seat Size	520W x 480D
Gas Height	480 - 620H
Weight Rating	130kg

Features :

- AFRDI level 6
- Fully ergonomic high back fabric chair
- injection moulded foam seat
- Seat and back tilt with gas lift

Certifications :



Finish Options :

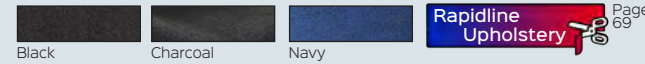

EM300 CHAIR - EM300

Specifications :

Overall Size	920 - 1050H x 480W x 525D
Seat Size	490W x 440D
Gas Height	460 - 590H
Weight Rating	110kg

Features :

- Fully ergonomic, height adjustable
- Seat available in fabric or PU
- Mesh back with Injection moulded foam seat
- Arms, Chrome base and Drafting kit available for extra

Certifications :



Finish Options :

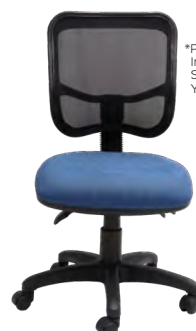
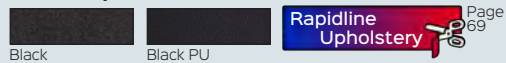

PO500 CHAIR - PO500

Specifications :

Overall Size	1020 - 1150H x 550W x 570D
Seat Size	530W x 510D
Gas Height	490 - 590H
Weight Rating	150kg

Features :

- AFRDI level 6, heavy duty mechanism
- Fully ergonomic high back fabric chair
- injection moulded foam, extra large seat
- Seat and back tilt with gas lift

Certifications :



Finish Options :



OPERATOR CHAIRS & ACCESSORIES

ET20 CHAIR - ET20

Specifications :

Overall Size	830 - 940H x 480W x 460D
Seat Size	480W x 460D
Gas Height	420 - 530H
Weight Rating	100kg

Finish :

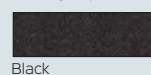

Black

Certifications :



Features :

- Black fabric medium back chair
- Gas lift, back and seat tilt
- Injection moulded foam



CHAIR ACCESSORIES

The Adjustable arm, Chrome base and Drafting kit accessories are compatible with :

- EC070CM
- EG100CH
- EM300
- EG400
- PO500
- EC070BM
- EC070CH
- EC070BH
- ET20

ADJUSTABLE ARMS - ADJ ARMS

Specifications :

Overall Height	250mm - 320mm
Overall Width	230mm
Overall Depth	260mm
Arm Pad Width	85mm
Arm Pad Depth	260mm

Finish :

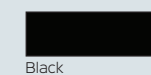

Black

Certifications :



Features :

- Adjustable height
- Simple assembly



EC070BM DRAFTING - EC070BM DRAFTING

Specifications :

Overall Size	1060 - 1230H x 500W x 450D
Seat Size	500W x 450D
Gas Height	630 - 800H
Weight Rating	120kg

Finish :

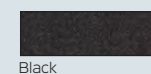

Black

Certifications :



Features :

- Medium back drafting chair
- Back tilt, gas lift
- Injection moulded foam



CHROME BASE - CH BASE

Specifications :

Overall Height	150mm
Diameter	650mm

Finish :

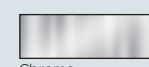

Chrome

Certifications :



Features :

- Quick and easy way to upstyle your chair
- Stylish and up market look
- Polished Aluminium
- Castors not included



DRAFTNG KIT - DRAFTNG KIT

Specifications :

Overall Height	150mm
Diameter	650mm

Finish :



Chrome / Black

Certifications :



Features :

- Used to create a drafting height chair
- Adds height to your operator chair
- Includes foot ring for resting
- Use with drafting height table or height adjustable desk



DS DESK STOOL - DS DESK

Specifications :

Overall Size	450 - 570H x 600 Diameter
Seat Size	450 - 570H x 400 Diameter
Weight Rating	100kg

Finish :

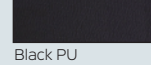

Black PU

Features :

- 400mm round seat desk stool
- Easy to clean black PU material
- Black spider base
- Height adjustable

Certifications :



LAB CHAIR - LAB CH

Specifications :

Overall Size	845 - 960H x 470W x 430D
Seat Size	420 - 540H x 470W x 435D
Weight Rating	110kg

Finish :

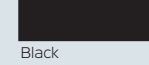

Black

Features :

- Height adjustable Laboratory chair
- Moulded polyurethane
- Contoured waterfall seat pan
- Seat and back tilt

Certifications :



YOYO CHAIR

Specifications :

Overall Size	730-820H x 600W x 600D
Seat Size	420-510H x 450W x 440D
Weight Rating	110kg

Finish :



Dark Grey fabric / Black frame

Features :

- Height adjustable swivel chair
- Moulded foam seat and back
- Nylon base with castors
- Wire-control mechanism

Certifications :



DS COUNTER STOOL - DS COUNTER

Specifications :

Overall Size	650 - 870H x 600 Diameter
Seat Size	650 - 870H x 400 Diameter
Weight Rating	100kg

Finish :



Black PU / Chrome

Features :

- 400mm round seat counter stool
- Chrome drafting ring
- Easy to clean Black PU material
- Black spider base

Certifications :



LAB STOOL - LAB ST

Specifications :

Overall Size	965 - 1185H x 470W x 500D
Seat Size	640 - 850H x 460W x 440D
Weight Rating	110kg

Finish :



Black / Chrome

Features :

- Moulded polyurethane
- Contoured waterfall seat pan
- Tilting back rest with infinite lock
- Height adjustable, chrome drafting ring

Certifications :



YOYO STOOL

Specifications :

Overall Size	820 - 1020H x 600W x 600D
Seat Size	520 - 720H x 450W x 440D
Weight Rating	110kg

Finish :



Dark Grey fabric / Black frame

Features :

- Height adjustable sit-stand chair
- Moulded foam seat and back
- Nylon base with castors and footing
- Wire-control mechanism

Certifications :



BREAKOUT AND VISITOR CHAIRS

WMVBK CHAIR - WMVBK

Specifications :

Overall Size	890H x 570W x 460D
Seat Size	480H x 480W x 480D
Weight Rating	120kg

Finish Options :

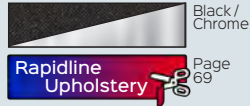

Features :

- Mesh back and fabric seat
- Chrome frame and legs
- Curved plastic arm rests
- Seat can be upholstered in house fabrics

Certifications :



WMCC CHAIR - WMCC

Specifications :

Overall Size	940H x 625W x 620D
Seat Size	440H x 470W x 470D
Weight Rating	120kg

Finish Options :



Features :

- Cantilever chrome base
- Comfortable mesh material on back
- Fixed Arms
- Fabric seat

Certifications :



WFV100 CHAIR - WFV100 BL

Specifications :

Overall Size	930H x 570W x 580D
Seat Size	475H x 450W x 435D
Weight Rating	120kg

Finish :



Features :

- Comfortable black fabric chair
- Chrome sled base
- Modern and stylish design
- Linkable bases

Certifications :



V100 CHAIR - V100

Specifications :

Overall Size	800H x 500W x 450D
Seat Size	460H x 450W x 450D
Weight Rating	120kg

Finish :



Features :

- Comfortable black fabric
- Black frame
- Stackable

Certifications :



NOVA CHAIR - NOVA

Specifications :

Overall Size	780H x 540W x 460D
Seat Size	445H x 448W x 444D
Weight Rating	110kg

Finish Options :



Features :

- Stackable
- Linkable
- Fabric seat and back
- Black powdercoated frame



P100 CHAIR - P100

Specifications :

Overall Size	845H x 450W x 370D
Seat Size	440H x 450W x 370D
Weight Rating	130kg

Finish :

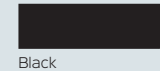

Features :

- Polypropylene plastic chair
- Stackable
- Sturdy frame
- Ventilation hole in back

Certifications :



FRAME CHAIR - FRAME BL

Specifications :

Overall Size	790H x 470W x 500D
Seat Size	455H x 420W x 410D
Weight Rating	120kg

Finish :

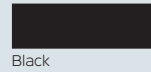

Black

Features :

- Perforated back rest and polypropylene seat
- Stackable with linking feature
- Solid rod base
- SGS: EN12520 Certification

Certifications :



VIVID CHAIR - VIVID

Specifications :

Overall Size	820H x 455W x 510D
Seat Size	460H x 455W x 470D
Weight Rating	120kg

Finishes :



Black

White

Features :

- Large polypropylene shell seat
- Powdercoated steel sled base
- Nylon glides under frame
- Stackable

Certifications :



PMVBK CHAIR - PMV- BK

Specifications :

Overall Size	810H x 530W x 460D
Seat Size	450H x 455W x 460D
Weight Rating	110kg

Finish :



Black / Chrome

Features :

- Black mesh back chair
- Plastic seat
- Stackable with linking feature
- Chrome sled base and frame

Certifications :



TEMPO CHAIR - TEMPO

Specifications :

Overall Size	820H x 550W x 570D
Seat Size	420H x 480W x 420D
Weight Rating	110kg

Finishes :



Charcoal / Black

Black / White

Features :

- Fabric Seat
- Powdercoat sled base
- Linking
- Stackable

Certifications :



Black PU / Black



NEW
Black PU / Black

ZING CHAIR - ZING

Specifications :

Overall Size	810H x 465W x 430D
Seat Size	440H x 465W x 430D
Weight Rating	120kg

Finish Options :



Black / Chrome

Rapidline Upholstery Page 69

Features :

- Large plastic back and seat
- Linkable and Stackable
- Chrome sled base with feet
- Seat pads available in Rapidline upholstery colours for extra

Certifications :



PIPPEE CHAIR - PIPPEE

Specifications :

Overall Size	860H x 400W x 380D
Seat Size	450H x 400W x 380D
Weight Rating	150kg

Finish Options :

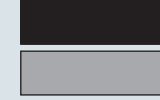

Black

Grey

Green

Features :

- Polypropylene plastic
- Stackable
- High luster shine
- Holds up to 150kg under intended use

Certifications :



BREAKOUT AND VISITOR CHAIRS

MAUI CHAIR - MAUI GB

Specifications :

Overall Size	840H x 530W x 460D
Seat Size	450H x 465W x 450D
Weight Rating	135kg

Finishes :



Features :

- Polypropylene chair
- White and Slate-Grey frame
- Grey fabric seat cover included
- Made from 100% recyclable materials

Certifications :



LUCID CHAIR - LUCID

Specifications :

Overall Size	795H x 500W x 500D
Seat Size	450H x 440W x 400D
Weight Rating	110kg

Seat Finishes :



Features :

- Concealed Feet Buttons
- Polypropylene Chair
- Textured Seat and back
- Mix and Match seats and bases

Certifications :



Leg Finishes :



VIRGO CHAIR - VIRGO

Specifications :

Overall Size	825H x 440W x 440D
Seat Size	470H x 440W x 440D
Weight Rating	110kg

Finish Options :



Features :

- Timber leg
- Polypropylene shell
- Comfortable fabric seat pad

Certifications :



COMFO CHAIR - COMFO

Specifications :

Overall Size	970H x 570W x 600D
Seat Size	460H x 510W x 490D
Weight Rating	110kg

Finish :



Features :

- Black PU seat and back
- Chrome cantilever base
- Padded curved arm rests

Certifications :



LEO CHAIR - LEO

Specifications :

Overall Size	830H x 460W x 410D
Seat Size	450H x 420W x 410D
Weight Rating	100kg

Finish Options :

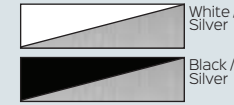

Features :

- Plastic hospitality chair
- Suitable for indoor or outdoor use
- Aluminium legs

Certifications :



FERNANDO CHAIR - FERNANDO

Specifications :

Overall Size	920H x 425W x 420D
Seat Size	440H x 425W x 420D
Weight Rating	90kg

Finish :



Features :

- Stylish black PU seat and back
- Chrome frame
- Cut out feature in back of chair
- Stackable

Certifications :



WIMBLEDON CHAIR - WIMBLEDON

Specifications :

Overall Size	785H x 435W x 460D
Seat Size	440H x 400W x 430D
Weight Rating	120kg

Finish :



Black / Chrome

Features :

- Plastic seat and back
- Chrome sled base
- Linkable and Stackable
- SGS: EN12520 Certification

Certifications :



*Linked Wimbledon Side chairs shown with arms, middle without.

WIMBLEDON WITH ARMS - WIMBLEDON WITH ARMS

Specifications :

Arms	205H x 30W x 285D
Weight Rating	120kg

Finish :



Black / Chrome

Features :

- Plastic seat and back with arms
- Chrome sled base
- Linkable
- Stackable

Certifications :



WIMBLEDON TABLET - WTAB

Specifications :

Tablet	255W x 400D
Height from seat	215mm

Finish :



Black / Chrome

Features :

- Plastic seat and back
- Chrome sled base
- Foldable Tablet

Certifications :



WIMBLEDON PADS - WSP | WBP

Specifications :

Seat Size	440H x 425W x 430D
Back Size	245H x 455W
Weight Rating	120kg

Finish Options :



Black Fabric



Page 69

Features :

- Stocked in black fabric
- Can be upholstered in Rapidline fabrics
- Seat pad - WSP sold separately
- Back pad - WBP sold separately

Certifications :



*Standard Black



*Pictured with Ink Fabric, Surface textiles Yarra range

ZOLA CHAIR - ZOLA

Specifications :

Overall Size	800H x 460W x 500D
Seat Size	430H x 460W x 440D
Weight Rating	100kg

Finish :



Black / Chrome

Features :

- Black plastic seat
- Curved back
- Chrome frame with sled base
- Stackable

Certifications :



CHAIR TROLLEY - Z TROLLEY

Specifications :

Overall Size	440 H x 800W x 620 D
Weight Rating	Maximum of 30 chairs
Compatible with	<ul style="list-style-type: none"> • PMVBK • FRAME BL • ZING • ZOLA • WIMBLEDON

Finish :



Black

Certifications :



BREAKOUT CHAIRS & STOOLS, CUSHIONS

TAURUS CHAIR - TAURUS

Specifications :

Overall Size	735H x 540W x 460D
Seat Size	440H x 440W x 435D
Weight Rating	110kg

Finish Options :



Black / Chrome

Features :

- Chrome frame and legs
- Wrap around polypropylene shell
- Cut out feature on back
- Stackable

Certifications :



VIRGO BAR STOOL - VIRGO ST

Specifications :

Overall Size	820H x 475W x 475D
Seat Size	770H x 440W x 450D
Weight Rating	110kg

Finish Options :



Black / Timber

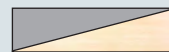

Grey / Timber



Green / Timber

Features :

- Modern bar stool
- Oak coloured frame
- Curved polypropylene plastic seat pan



CAD Cushion

Specifications :

Overall Width	460mm
Overall Depth	460mm
Overall Height	40mm
Overall height of Caddy with cushion	610mm

Finish Options :

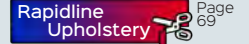

- Choose from any fabric in any of our partnered ranges on page 69

Features :

- Fabric seat Cushion. *Caddy not included



TAURUS BAR STOOL - TAURUS STOOL

Specifications :

Overall Size	1050H x 525W x 460D
Seat Size	750H x 435W x 455D
Weight Rating	110kg

Finish Options :



Black / Chrome

Features :

- Chrome frame and legs
- Wrap around polypropylene shell
- Cut out feature on back
- Leg rest on chrome base / frame

Certifications :



ARIES BAR STOOL - ARIES ST

Specifications :

Overall Size	853H x 455W x 545D
Seat Size	760H x 440W x 450D
Weight Rating	110kg

Finish Options :



Black / Black



Grey / Black



Green / Black

Features :

- Stylish black metal curved frame
- Polypropylene plastic seat pan
- Leg rest on base / frame



GMP3 Cushion

Specifications :

Overall Width	460mm
Overall Depth	475mm
Overall Thickness	40mm
Overall height of GMP3 with cushion	660mm

Finish Options :

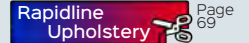

- Choose from any fabric in any of our partnered ranges on page 69

Features :

- Fabric seat Cushion. *Mobile Ped not included



Chair and Screen Upholstery

For a wider colour selection than our standard express range, we can upholster certain products in a range of extended Rapidline Upholstery fabrics, or *your fabric of choice.

UPHOLSTERY CHAIRS :

- EM300
- EC070CM
- EG100
- PO500
- MOTION
- GESTURE
- LUMINOUS
- ERGO
- HARTLEY TASK
- HARTLEY VISITOR
- KAL
- ZOOM
- WMCC
- WMVBK
- WIMBLEDON (Back and Seat Pad)
- VIVA chair (Seat Pad)
- CONNECT OTTOMAN
- MARS OTTOMANS
- ZING (Back and Seat Pad)
- GMP3 Cushion
- CAD Cushion



UPHOLSTERY SCREENS :

- SHUSH30+ Screens
- RAPID Screens
(Fabric Top Half of Screen Panel)
- Freestanding Acoustic Screens
- Infinity, Eternity & BOOST+ Screens

laine[™]
Suzette

INSTYLE
THINK PLUS

WORTLEY
Furnishing in Style
ACCESS

sustainable
living
FABRICS
RENEGADE

surface
TEXTILES
Yarra

rim
Fabrics
design • technology • sustainability
Sensation Woven

WARWICK
Ashcroft

WARWICK
Beachcomber

WARWICK
LUSTRELL CHARISMA

Lead Times and Additional Charges Apply
*Option to supply your own fabric

GLASSBOARD

Specifications :

Size Options	<ul style="list-style-type: none"> • GB96 - 900mm W x 600mm H • GB129 - 1200mm W x 900mm H • GB159 - 1500mm W x 900mm H • GB1512 - 1500mm W x 1200mm H • GB189 - 1800mm W x 900mm H • GB1812 - 1800mm W x 1200mm H • GB2112 - 2100mm W x 1200mm H • GB2412 - 2400mm W x 1200mm H
Overall Depth	15mm

Features :

- Compatible with any whiteboard markers or liquid chalk markers (not included)
- Super clear 4mm toughened glassboard
- Magnetic surface - Requires super strong magnets
- Galvanised steel backing
- 25mm chrome fittings

Finish :

	White
---	-------



LECTERN - LCT12 BL

Specifications :

Overall Size	1200H x 445W x 450D
Top Shelf Size	600W x 400D
Second Shelf Size	550W x 260D

Features :

- Heavy duty lectern
- Angled top shelf for presentations
- Second shelf for storage
- Black powdercoated finish
- Detachable adjustable battery powered LED light
- Castors

Finish :

	Black
---	-------

Certifications :



PINBOARD



Specifications :

Size Options	<ul style="list-style-type: none"> • PIN96 - 900mm W x 600mm H • PIN129 - 1200mm W x 900mm H • PIN1212 - 1200mm W x 1200mm H • PIN159 - 1500mm W x 900mm H • PIN1512 - 1500mm W x 1200mm H • PIN189 - 1800mm W x 900mm H • PIN1812 - 1800mm W x 1200mm H • PIN2412 - 2400mm W x 1200mm H
Overall Depth	15mm

Features :

- Wall mounted pinboard
- Concealed corner wall fixings
- Felt surface
- Includes 4 Pins
- Galvanised steel backing
- Low density fibreboard core

Finish :

	Blue
	Grey



CORKBOARD

Specifications :

Board Size Options	<ul style="list-style-type: none"> • C96 - 900W x 600H • C129 - 1200W x 900H • C1212 - 1200W x 1200H • C159 - 1500W x 900H • C1512 - 1500W x 1200H • C189 - 1800W x 900H • C1812 - 1800W x 1200H • C2412 - 2400W x 1200H
Overall Depth	15mm

Features :

- Composite corkboard aluminium frame
- Concealed corner wall fixings
- Suitable for pins or stickers

Finish :

	Corkboard
---	-----------



PRESENTATION RANGE

WHITEBOARD

Specifications :

Size	• W96 - 900H x 600W	• W129 - 1200H x 900W
Options	• W1212 - 1200H x 1200W	• W159 - 1500H x 900W
	• W1512 - 1500H x 1200W	• W189 - 1800H x 900W
	• W1812 - 1800H x 1200W	• W219 - 2100H x 900W
	• W2112 - 2100H x 1200W	• W2412 - 2400H x 1200W
Overall Depth	15mm	

Features :

- Wall mounted aluminium frame
- Magnetic surface
- Pen tray included
- Concealed corner fixing
- Acrylic polyester resin
- Includes fixing screws

Finish :



White



PORCELAIN WHITEBOARD

Specifications :

Size	• PWB96 - 900H x 600W	• PWB129 - 1200H x 900W
Options	• PWB1212 - 1200H x 1200W	• PWB159 - 1500H x 900W
	• PWB1512 - 1500H x 1200W	• PWB189 - 1800H x 900W
	• PWB1812 - 1800H x 1200W	• PWB2112 - 2100H x 1200W
	• PWB2412 - 2400H x 1200W	• PWB3012 - 3000H x 1200W
Overall Depth	15mm	

Features :

- Porcelain / Vitreous enamel surface (Polyvision E3 ceramic steel)
- Includes 4 x Magnets
- Includes fixing screws
- Includes pen tray

Finish :



White



MOBILE WHITEBOARD

Options :

MW129	1200mm W x 900mm H
MW159	1500mm W x 900mm H
MW1512	1500mm W x 1200mm H
MW189	1800mm W x 900mm H
MW1812	1800mm W x 1200mm H

Specifications :

Overall Height	1770mm
Overall Depth	550mm

Features :

- Mobile whiteboard with castors
- Includes pen tray
- Double sided
- Pivoting

Finish :



White



MOBILE PORCELAIN WHITEBOARD

Options :

PMW129	1200mm W x 900mm H
PMW1512	1500mm W x 1200mm H
PMW1812	1800mm W x 1200mm H

Specifications :

Overall Height	1770mm
Overall Depth	550mm

Features :

- Mobile whiteboard with castors
- Pivoting
- Double sided
- Porcelain / Vitreous enamel surface (Polyvision E3 ceramic steel)
- Includes pen tray

Finish :



White



DESK MOUNTED SCREENS

NEW ECO PANEL SCREENS

Dimensions :

Width	EPS750 - 740mm
Options	EPS1200 - 1190mm EPS1500 - 1490mm EPS1800 - 1790mm
Finished Height (with clamps)	400mm
Screen Height	384mm
Thickness	27mm

Features :

- Polyester fibre panel pinnable surface
- Radial corners
- *Requires additional Fixings. See below ECO Panel Clamps*
- *Clamps not included*

Finish Options :

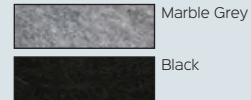

* EPS1500 BK

SLIDE ON SCREEN - SEPS70

Dimensions :

Overall Width	820mm
Overall Height	530mm
Thickness	27mm
Height from desk to cavity	400mm
Length from cavity to edge	700mm
Cavity Height	24mm
Corner Radius	40 Degrees

Features :

- Polyester fibre panel pinnable surface
- Suits 25mm Thick tops
- Requires no Fixings

Finish Options :

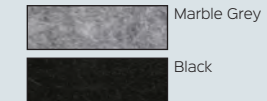

ECO PANEL CLAMPS

Specifications :

EPSCLAMP	Desk mounted clamp. Use for most workstations
EPSMC	Side mounted clamp. Use for Single workstations
BTBEPSC	Back to Back mounete. Use for Back to back workstations

Finish Options :

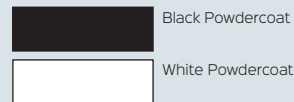

Features :

- Used for mounting ECO Panel Screens with a thickness of 16mm - 31mm
- Powdercoated clamps come in a set of 2
- Side and Back to Back versions screw in from bottom of desk



* EPSCLAMP



* EPSMC



* BTBEPSC

* Pictured below: EPS1500 MG screen with EPSCLAMPS WS



* Pictured above: EPS1800 BK screen with EPSMC BK clamps

1800mm HEIGHT ACOUSTIC SCREEN

Specifications :

Width	• A1518 - 1500mm
Options	• A1818 - 1800mm
Height	1800mm
Thickness	50mm

Features :

- Free standing dividing office panels
- Pinnable fabric with black pvc edging
- Silver freestanding feet

Finish Options :

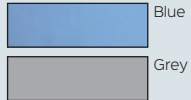

Certifications :



1500mm HEIGHT ACOUSTIC SCREEN

Specifications :

Width	• A1515 - 1500mm
Options	• A1815 - 1800mm
Height	1500mm
Thickness	50mm

Features :

- Free standing dividing office panels
- Pinnable fabric with black pvc edging
- Silver freestanding feet

Finish Options :

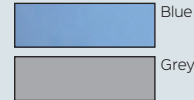

Certifications :



PERSONAL STORAGE

GO STEEL MOBILE PEDESTAL - GMP3

Specifications :

Overall Width	460mm
Overall Depth	472mm
Overall Height	610mm
Top Drawer Size	390W x 475D x 65H
Filing Drawer Size	390W x 475D x 250H
Weight Rating	30kgs per Drawer

Finishes :

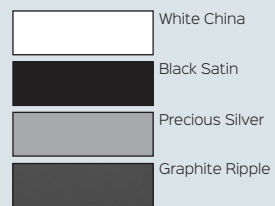

Features :

- For larger workstations
- Lockable - Supplied with 2 keys
- Stores foolscap files back to front
- Flush drawer front
- Full extension ball bearing runners
- Fifth wheel for stability
- Keyed alike locks available for extra

Certifications :



GO STEEL SLIMLINE MOBILE PED - GSP3

Specifications :

Overall Width	300mm
Overall Depth	472mm
Overall Height	610mm
Top Drawer Size	230W x 460D x 65H
Filing Drawer Size	230W x 460D x 250H
Weight Rating	30kgs per Drawer

Finishes :

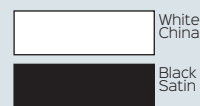

Features :

- Slimline for smaller workstations
- Lockable - Supplied with 2 keys
- Stores foolscap files side to side
- Flush drawer front
- Ball bearing runners
- Fifth wheel for stability
- Keyed alike locks available for extra

Certifications :



ETERNITY SLIMLINE MOBILE PED - EMP3 WB

Specifications :

Overall Width	300mm
Overall Depth	535mm
Overall Height	580mm
Top Drawer Size	240W x 500D x 70H
Filing Drawer Size	240W x 500D x 250H
Weight Rating	30kgs per Drawer

Finishes :



Features :

- Stylish curved corners
- Slimline for smaller workstations
- Powdercoated steel mobile pedestal
- 2 personal drawers and 1 file drawer
- Fifth wheel for stability and anti-tilt
- Lockable - Supplied with 2 keys

Certifications :



*Graphite Ripple



*Precious Silver



GO STEEL MOBILE CADDY - GCADN

Specifications :

Overall Size	618H x 1050W x 500D
Tambour (internal)	500H x 560W x 470D
Top 2 drawers (internal size)	70H x 320W x 460D
Bottom filing drawer (internal)	240H x 320W x 460D

Finishes :

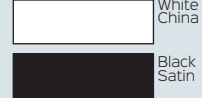

Certifications :



Features :

- On castors, with 5th Wheel On File Drawer
- Lockable pedestal and tambour door with 2 keys supplied
- 2 drawers and 1 file drawer, files run front to back
- Tambour section with adjustable shelf
- GCADN-L - Tambour door on left hand side
- GCADN-R - Tambour door on right hand side
- Seat pad available for additional extra



GO STEEL FILING CABINET

Specifications :

Width	460mm
Depth	620mm
Drawer Options	<ul style="list-style-type: none"> • GFCA2 - 2 drawer - 705mm H • GFCA3 - 3 drawer - 1016mm H • GFCA4 - 4 drawer - 1321mm H

Finishes :

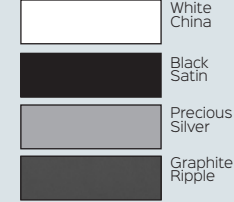

Certifications :



Features :

- Lockable - Supplied with 2 keys
- Heavy duty and Fully riveted
- Ball bearing runners
- 40kg weight capacity per drawer

*Silver Grey



*White China



*Graphite Ripple



*Black Ripple



GO STEEL LATERAL FILING CABINET

Specifications :

Width	900mm
Depth	473mm
Height	<ul style="list-style-type: none"> • GLF2 - 2 drawer - 705mm • GLF3 - 3 drawer - 1016mm • GLF4 - 4 drawer - 1321mm

Finishes :



Certifications :



Features :

- Lockable - Supplied with 2 keys
- Riveted construction for extra strength
- Heavy duty and Anti-tilt
- 2 rows of folders per drawer



900mm Wide TAMBOUR DOOR CUPBOARD

Specifications :

Height Options	• GTD109 - 1016mm • GTD129 - 1200mm • GTD199 - 1981mm
Depth	473mm
Width	900mm

Features :

- Easy glide track
- Magnetic anti slam rail keeps doors closed
- Fully riveted for extra strength
- 40kg weight rating per shelf
- Fully Lockable with 2 keys supplies (master series)
- Adjustable feet for leveling
- Tambour door cupboard unit only, shelves sold separately
- Optional extra shelves and range of accessories available

Finishes :

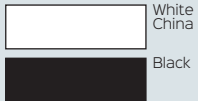

Certifications :



1200mm Wide TAMBOUR DOOR CUPBOARD

Specifications :

Height Options	• GTD1012 - 1016mm • GTD1212 - 1200mm • GTD1912 - 1981mm
Depth	473mm
Width	1200mm

Features :

- Easy glide track
- Magnetic anti slam rail keeps doors closed
- Fully riveted for extra strength
- 40kg weight rating per shelf
- Fully Lockable with 2 keys supplies (master series)
- Adjustable feet for leveling
- Tambour door cupboard unit only, shelves sold separately
- Optional extra shelves and range of accessories available

Finishes :

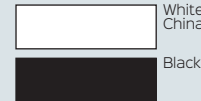

Certifications :



Pictured Left : GTD199 WC
White China, 1981mm H x 900mm W

Top shelf is a Slotted shelf with dividers
Middle shelf is a standard plain shelf
Bottom shelf is a Pull out filing frame
**Standard tambour does not come with add-on shelving and accessories

Pictured Below: GTD129 BL
Black, 1200H x 900W

**Standard tambour does not come with add-on shelves



Pictured Left : GTD1912 WC
White China, 1981mm H x 1200mm W

Pictured bottom shelf is a Pull out filing frame
**Standard tambour does not come with add-on shelving and accessories

Pictured Below: GTD1012 WC
White, 1016mm H x 1200mm W

**Standard tambour does not come with add-on shelves



PLANTER BOX

Specifications :

Width	• PB900 - Suits 900mm W unit
Options	• PB1200 - Suits 1200mm W unit
Size	230mm H x 473mm D

Features :

- Space for 3 x 200mm plant pots (**plants and pots not included**)
- Incorporated drip tray
- Use on top of tambour door cupboards or lateral filing cabinets

Finishes :

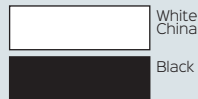

Certifications :



PLAIN SHELF

Specifications :

Width	• GTD900 - Suits 900mm W unit
Options	• GTD1200 - Suits 1200mm W unit
Size	470mm D x 30mm T

Features :

- Standard shelf to use with Tambour door cupboards
- Easy to install - Clips supplied
- Easy to adjust to different heights

Finishes :

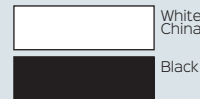

Certifications :



PULL OUT SHELF

Specifications :

Width	GG09PS - Suits 900mm W unit
Options	GG12PS - Suits 1200mm W unit
Size	470mm D x 30mm T

Features :

- Pull out shelf for use in tambour door cupboard units
- Shelf slides out for easy operation to find or work on files

Finishes :

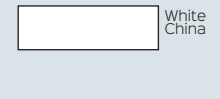

Certifications :



ROLL OUT FILING FRAME

Specifications :

Width	• GG09FF - 750mm width for 900mm wide unit - can take 1 row of foolscap folders
Options	• GG12FF - 1050mm width for 1200mm wide unit - can take 2 rows of foolscap folders

Features :

- Store foolscap folders and roll out for easy access to files

Finishes :



Certifications :



SLOTTED SHELF AND DIVIDERS

Specifications :

Shelf Options	• GG09SLOT - Suits 900mm W unit • GG12SLOT - Suits 1200mm W unit
Dividers	GS7D - pack of 5 slotted shelf dividers

Finishes :

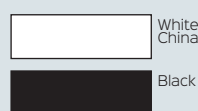

Certifications :



Features :

- Slotted shelf for use in tambour door cupboards
- Accepts separate slotted shelf dividers
- Rear support for dividers
- Reinforced shelf for heavy duty durability and stability
- Great for dividing documents and folders
- Holds folders vertically



*White China, 1200mm slotted shelf, 2 x Dividers

*Black, 1200mm slotted shelf



*White China, 900mm slotted shelf, 2 x Dividers

*Black, 900mm slotted shelf, 5 x Dividers

SHELVING UNIT - GSC9422

Specifications :

Overall Width	910mm
Overall Depth	400mm
Overall Height	2200mm

Features :

- Flat packed
- Clip together easy to assemble
- Includes 5 adjustable shelves
- In silver grey finish only
- 40kg weight rating per shelf

Finishes :

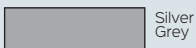

Silver Grey

Certifications :



GO STEEL WARDROBE - GWA18

Specifications :

Overall Width	910mm
Overall Depth	450mm
Overall Height	1830mm

Features :

- Lockable GO steel swing door wardrobe
- Hanging rail and 3 shelves
- 4 separate storage compartments
- Fully lockable
- Supplied with 2 keys

Finishes :

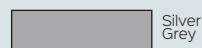

Silver Grey

Certifications :

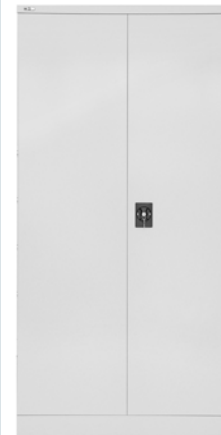

OFFICE LOCKER - OFL138N WC

Specifications :

Overall Width	800mm
Overall Depth	486mm
Overall Height	1375mm

Features :

- Space efficient storage system for offices
- 6 lockable individual compartments per unit
- Removable shelf per locker
- Mail slot on each door
- Name holder fitted to each door
- 4 easy adjustable levelling feet
- Unit finished in powdercoat
- Combination locking system with private and public functions available

Finishes :



White China

Certifications :



GO STEEL CUPBOARD

Specifications :

Size	910mm W x 450mm D
Height	• GCA10 - 2 shelves - 1015mm
Options	• GCA18 - 3 shelves - 1830mm
	• GCA20 - 4 shelves - 2000mm

Features :

- GO steel flush lock cupboard
- Supplied with 2 keys
- GCWSG Shelf and coat rail as optional extra for use in cupboard

Finishes :

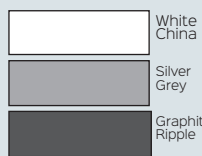

White China

Silver Grey

Graphite Ripple

Certifications :



*Graphite Ripple



*White China

CHAIR MATS FOR CARPETS

Specifications :

MAT S	<ul style="list-style-type: none"> • Small • 915mm W x 1200mm D x 2mm T
MAT L	<ul style="list-style-type: none"> • Large • 1150mm W x 1350mm D x 2mm T

Features :

- Composition: PVC - 75%, DDTP (PVC Plasticizer) - 20%, ABS - 2%, Stabilizer - 2%, Colour Pigment - 1%
- Dimpled mat for low pile carpet floors
- Tested for fire retardancy

Finish :



Clear

Certifications :



CHAIR MATS FOR HARD FLOORS

Specifications :

MAT SM S	<ul style="list-style-type: none"> • Small • 915mm W x 1200mm D x 2mm T
MAT SM L	<ul style="list-style-type: none"> • Large • 1150mm W x 1350mm D x 2mm T

Features :

- Composition: - PVC - 75%, DDTP (PVC Plasticizer) - 20%, ABS - 2%, Stabilizer - 2%, Colour Pigment - 1%
- Use smooth for hard floors
- Tested for fire retardancy

Finish :

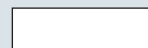

Clear

Certifications :



* Chair not included

UTILITY TROLLEY - TR3

Specifications :

Overall Width	800mm
Overall Depth	600mm
Overall Height	900mm
Weight Rating	100kg

Features :

- Utility trolley
- 3 tiers of storage space
- Castor wheels for ease of movement
- Strong, sturdy frame

Finish :

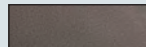

Ironstone

Certifications :



CORNER LOZENGE

Specifications :

LOZENGE25	Suits 25mm thick desks
LOZENGE33	Suits 33mm thick desks
Overall Width	250mm
Overall Depth	480mm

Features :

- Converts desk and return to a corner workstation
- Adds diagonal for user to sit at
- Fits 25mm or 33mm deep melamine tops

Finishes :

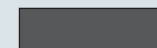

Graphite

Certifications :

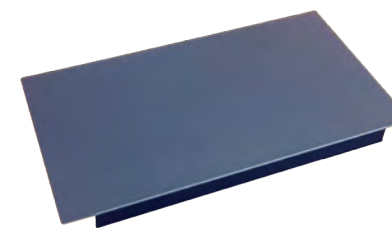

MELAMINE LOCKERS

Melamine lockers offer a personal storage solution that blends into your space. Use in both office and educational applications. Each locker includes 2 x keys per lock.

Various internal features in each compartment. Moisture resistant melamine and MDF doors with soft close hinges, and adjustable levelling feet to each unit.

Certifications :



STEP DOOR - SDWRML380/2

Specifications :

Overall Height	1850mm
Overall Width	380mm
Overall Depth	455mm

Features :

- MR Melamine carcass
- MDF doors
- Soft close hinges
- Adjustable leveling feet
- 1 x hanging rail per compartment
- Includes 2 x keys per lock
- Digital Lock option for extra

Finish Options :

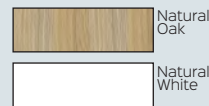

SINGLE LOCKER - WRML-305/1

Specifications :

Overall Height	1850mm
Overall Width	305mm
Overall Depth	455mm

Features :

- MR Melamine carcass
- MDF doors
- Soft close hinges
- Adjustable leveling feet
- 1 x hanging rail
- 1 x hat shelf
- Includes 2 x keys per lock
- Digital Lock option for extra

Finish Options :



Melamine lockers offer a personal storage solution that blends into your space. Use in both office and educational applications. Each locker includes 2 x keys per lock.

Various internal features in each compartment. Moisture resistant melamine and MDF doors with soft close hinges, and adjustable levelling feet to each unit.

Finish Options :



Certifications :



2 DOOR LOCKER - WRML-305/2

Specifications :

Overall Size 1850H x 305W x 455D

Features :

- MR Melamine carcass
- MDF doors
- Soft close hinges
- Adjustable leveling feet
- 1 x hanging rail per compartment
- Includes 2 x keys per lock
- Digital Lock option for extra

3 DOOR LOCKER - WRML-305/3

Specifications :

Overall Size 1850H x 305W x 455D

Features :

- MR Melamine carcass
- MDF doors
- Soft close hinges
- Adjustable leveling feet
- 3 x Locker compartments
- Includes 2 x keys per locker
- Digital Lock option for extra

4 DOOR LOCKER - WRML-305/4

Specifications :

Overall Size 1850H x 305W x 455D

Features :

- MR Melamine carcass
- MDF doors
- Soft close hinges
- Adjustable leveling feet
- 4 x Locker compartments
- Includes 2 x keys per locker
- Digital Lock option for extra

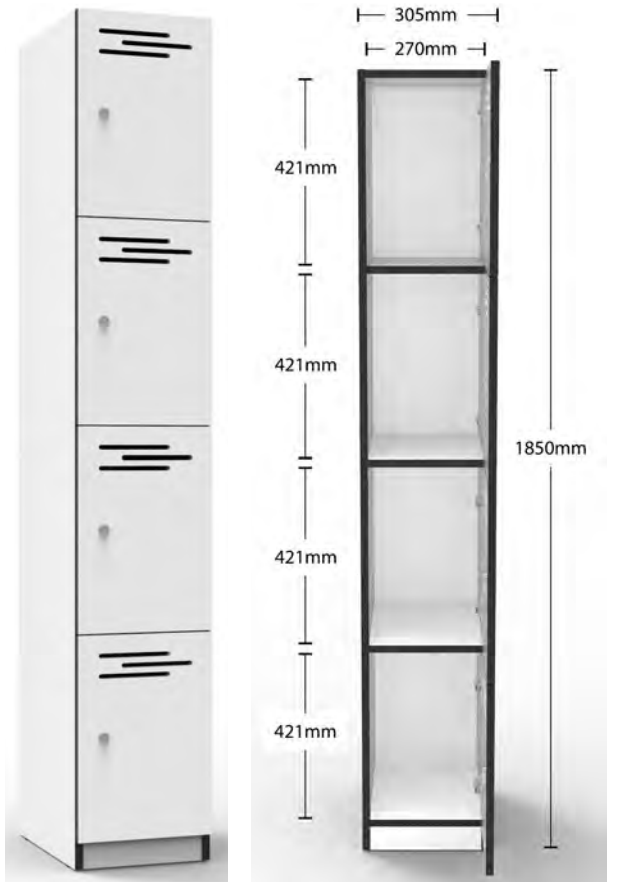
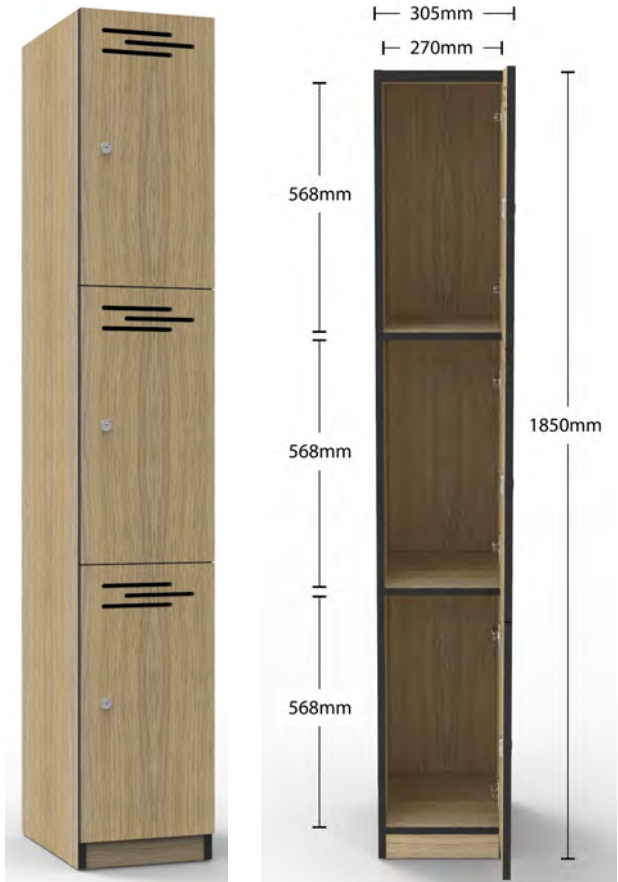
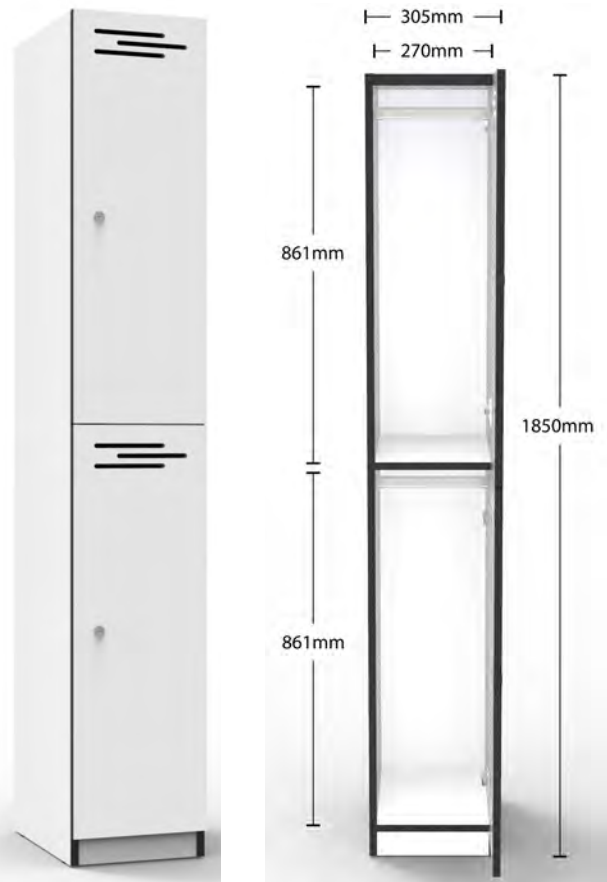

STEEL LOCKERS

Steel lockers offer an easy way to store personal belongings. Includes 2 keys supplied per locker compartment. Choose from single, 2 or 4 door options to suit your requirements, or a step locker which provides 2 hanging spaces.

Finish Options :

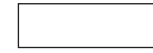

White China
(305W units only)



Silver Grey
(305W & 380W units)



SINGLE DOOR LOCKER

Specifications :

Width Options	• GL305/1 - 305mm • GL380/1 - 380mm
Size	1830mm H x 455mm D

Features :

- Riveted construction for extra strength
- Vented doors for ventilation
- 1 x hat shelf, 1 x coat rail storage
- Full length stiffeners fitted to each door for rigidity

2 DOOR LOCKER

Specifications :

Width Options	• GL305/2 - 305mm • GL380/2 - 380mm
Size	1830mm H x 455mm D

Features :

- Riveted construction for extra strength
- Vented doors for ventilation
- 1 x coat hook per compartment
- Full length stiffeners fitted to each door for rigidity

4 DOOR LOCKER

Specifications :

Width Options	• GL305/4 - 305mm • GL380/4 - 380mm
Size	1830mm H x 455mm D

Features :

- Riveted construction for extra strength
- Vented doors for ventilation
- Full length stiffeners fitted to each door for rigidity

STEP LOCKER - GSL380

Specifications :

Overall Size	1830H x 380W x 455D
--------------	---------------------

Features :

- Riveted construction for extra strength
- Vented doors for ventilation
- 1 x hanging rail per compartment
- Full length stiffeners fitted to each door for rigidity
- *Silver Grey finish only



LOCKER STAND

Specifications :

Width Options	• SB2305 - 610mm W for 2 lockers • SB3305 - 915mm W for 3 lockers
Size	455mm D x 150mm H

Finishes :

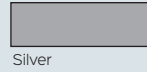

Silver

Features :

- Locker stand to bank 2 or 3 lockers
- Suitable for 305mm wide lockers only
- Silver powdercoated frame and black levelling feet
- Raise lockers off floor to allow for easy cleaning underneath and extra stability when joined together



SEAT AND STAND

Specifications :

Width Options	• S+S2305 - 610mm W for 2 lockers • S+S3305 - 915mm W for 3 lockers
Size	700mm D x 350mm H

Finishes :



Timber / Silver

Features :

- Seat and stand to suit bank of 2 or 3 lockers
- Suitable for 305mm wide lockers
- Powdercoated frame and oak style seat
- Raise lockers off floor and add a bench seat in front for use in locker rooms, schools, gyms and other applications



BENCH SEAT - BS1000

Specifications :

Overall Size	400H x 1000W x 360D
--------------	---------------------

Finishes :



Timber / Silver

Features :

- Single sided bench seat
- Light oak style wood slats
- Silver coated frame
- Black levelling feet



SLOPING TOP

Specifications :

Width	• G12830 - for single 305mm W locker
Options	• G32830 - for bank of 3 x 305mm W lockers
Height	270mm



Features :

- Sloping top in silver grey
- Use with either a single locker or bank of 3 lockers
- Suitable for 305mm wide lockers only
- Neat and easy to clean 30° degree sloping top

Finishes :

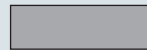

Silver



DIGITAL LOCK

Specifications :

Size	95H x 38W x 60D
Options	• DIGIPRILOCK - Private lock programming • DIGIPUBLOCK - Public lock programming



Features :

- Digital keypad code lock to be used with steel or melamine lockers as optional extra
- Public or private lock programming
- Use with both steel or melamine lockers
- *batteries not included***

Finishes :

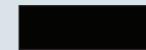

Black



BUTTERFLY LOCK - BUTTERFLY

Specifications :

Padlock Requirements	Suitable for use with padlock shafts 6mm-8mm and shackle 25mm-30mm
----------------------	--



Features :

- Butterfly lock for use with all GO Steel lockers to enable padlock facility on doors (padlock not included)
- Supplied fitted to lockers when ordered simultaneously

Finishes :



Chrome



WORKSTATIONS - FURNITURE - SEATING - STORAGE - ACCESSORIES



rapidline
FURNITURE FOR TODAY